

StudioTM Command

Series

Studio Command 1200

Studio Command 700

Studio Command H

User Manual

©High End Systems, Inc. 2005, All Rights Reserved

Information and specifications in this document are subject to change without notice. High End Systems, Inc. assumes no responsibility or liability for any errors or inaccuracies that may appear in this manual.

Trademarks used in this text: High End Systems, WholeHog III, xSpot Xtreme, Technobeam, Studio Spot, Studio Color, Studio Color 250, Studio Spot 250, Studio Beam, and Lithopatterns are registered trademarks; and Studio Command, TalkBack, Internal Effects, the High End Systems globe logo, Light Burst, the Hog logo are trademarks of High End Systems, Inc. or High End Systems Europe Ltd. Belden is a registered trademark of Belden, Inc. Philips is a registered trademark of Philips Lighting Company. Krytox is a registered trademark of DuPont.

Other trademarks and trade names may be used in this document to refer to either the entities claiming the marks and names or their products. High End Systems disclaims any proprietary interest in trademarks and trade names owned by others.

Studio Command™ User Manual

P/N 60600252 V4.2

Printed in the USA

January, 2007

HIGH END SYSTEMS®



Contacting High End Systems®

U.S. and the Americas

Sales Department

High End Systems, Inc.
2105 Gracy Farms Lane
Austin, TX 78758 USA
voice: 512.836.2242
fax: 512.837.5290
Toll Free: 800.890.8989

Customer Service

High End Systems, Inc.
2105 Gracy Farms Lane
Austin, TX 78758 USA
voice: 800.890.8989
fax: 512.834.9195
toll free: 800.890.8989

World Wide Web:

<http://www.highend.com>

Declaration of Conformity

according to ISO/IEC Guide 22 and EN45104

Manufacturer's name: High End Systems, Inc.
Manufacturer's address: 2105 Gracy Farms Lane
Austin, Texas 78758 USA

Distributor's name: High End Systems, Inc.
Distributor's address: 2105 Gracy Farms Lane
Austin, Texas 78758 USA

Declares that the product

Product Name: Studio Command 1200/700, Studio Command H
Product Number: All
Product Options: All

conforms to the following EEC directives:

73/23/EEC, as amended by 93/68/EEC

89/336/EEC, as amended by 92/31/EEC and 93/68/EEC

Equipment referred to in this declaration of conformity was first manufactured in compliance with the following standards in 2005:

Safety: EN 60598-1 : 1997
EN 60598-2-17 ; 1990
A1-A3 : 1998
A13: 1999

EMC:

EN 55022

Conducted Emissions Class A
Radiated Emissions Class A

ANSI C63.4

Class A

FCC 47 CFR Part 15

Class A

VCCI V-1/2001.04

Class A

EN 55024

EN 61000-4-2 4/8kV

EN 61000-4-3 A1 3V/m

EN 61000-4-4 1kV/0.5kV

EN 61000-4-5 2kV/1kV

EN 61000-4-6 3 Vrms

EN 61000-4-11 >95%-0.5p, 30%-25p, >95%-250p

Class A

EN 61000-3-2

EN 61000-3-3



USA, Thursday, March 06, 2008

Kenneth Stuart Hansen, Compliance Engineer

Product Modification Warning

High End Systems products are designed and manufactured to meet the requirements of United States and International safety regulations. Modifications to the product could affect safety and render the product non-compliant to relevant safety standards.

Mise En Garde Contre La Modification Du Produit

Les produits High End Systems sont conçus et fabriqués conformément aux exigences des règlements internationaux de sécurité. Toute modification du produit peut entraîner sa non conformité aux normes de sécurité en vigueur.

Produktmodifikationswarnung

Design und Herstellung von High End Systems entsprechen den Anforderungen der U.S. Amerikanischen und internationalen Sicherheitsvorschriften. Abänderungen dieses Produktes können dessen Sicherheit beeinträchtigen und unter Umständen gegen die diesbezüglichen Sicherheitsnormen verstoßen.

Avvertenza Sulla Modifica Del Prodotto

I prodotti di High End Systems sono stati progettati e fabbricati per soddisfare i requisiti delle normative di sicurezza statunitensi ed internazionali. Qualsiasi modifica al prodotto potrebbe pregiudicare la sicurezza e rendere il prodotto non conforme agli standard di sicurezza pertinenti.

Advertencia De Modificación Del Producto

Los productos de High End Systems están diseñados y fabricados para cumplir los requisitos de las reglamentaciones de seguridad de los Estados Unidos e internacionales. Las modificaciones al producto podrían afectar la seguridad y dejar al producto fuera de conformidad con las normas de seguridad relevantes.

Important Safety Information

Instructions pertaining to continued protection against fire, electric shock, and injury to persons are found in Appendix C. Please read all instructions prior to assembling, mounting, and operating this equipment.

Important: Informations De Sécurité

Les instructions se rapportant à la protection permanente contre les incendies, l'électrocution, excessif et aux blessures corporelles se trouvent dans l'Annexe C. Veuillez lire toutes les instructions avant d'assembler, de monter ou d'utiliser cet équipement.

Wichtige Sicherheitshinweise

Sicherheitsanleitungen zum Schutz gegen Feuer, elektrischen Schlag, und Verletzung von Personen finden Sie in Anhang C. Vor der Montage, dem Zusammenbau und der Inbetriebnahme dieses Geräts alle Anleitungen sorgfältig durchlesen.

Informazioni Importanti Di Sicurezza

Le istruzioni sulla protezione da incendi, folgorazione, e infortuni sono contenute nell'appendice C. Si prega di leggere tutte le istruzioni prima di assemblare, montare e azionare l'apparecchiatura.

Informacion Importante De Seguridad

En el Apéndice C se encuentran instrucciones sobre protección continua contra incendios, descarga eléctrica, y lesiones personales. Lea, por favor, todas las instrucciones antes del ensamblaje, montaje y operación de este equipo.

FCC Information

This equipment has been tested and found to comply with the limits for a Class A digital device, pursuant to part 15 of the FCC rules. These limits are designed to provide reasonable protection against harmful interference when the equipment is operated in a commercial environment. This equipment generates, uses, and can radiate radio frequency energy and, if not installed and

used in accordance with the instruction manual, may cause harmful interference to radio communications. Operation of this equipment in a residential area is likely to cause harmful interference, in which case the user will be required to correct the interference at his own expense.

Safety Symbols

The following international caution and warning symbols appear in margins throughout this manual to highlight messages.



CAUTION: This symbol appears adjacent to Caution messages. Not heeding these messages could result in personal injury and/or damage to equipment.



WARNING: This symbol appears adjacent to high voltage warning messages. Not heeding these messages could result in serious personal injury.



This symbol indicates the minimum focus distance from a combustible object.



This symbol cautions against mounting the fixture on a flammable surface.



This symbol indicates that, while operating, equipment surfaces may reach very high temperatures. Allow the fixture to cool before handling.

Warranty Information

Limited Warranty

Unless otherwise stated, your product is covered by a one year parts and labor limited warranty. Dichroic filters and LithoPatterns[®] high resolution glass gobos are not guaranteed against breakage or scratches to coating. It is the owner's responsibility to furnish receipts or invoices for verification of purchase, date, and dealer or distributor. If purchase date cannot be provided, date of manufacture will be used to determine warranty period.

Returning an Item Under Warranty for Repair

It is necessary to obtain a Return Material Authorization (RMA) number from your dealer or point of purchase BEFORE any units are returned for repair. The manufacturer will make the final determination as to whether or not the unit is covered by warranty. Lamps are covered by the lamp manufacturer's warranty.

Any Product unit or parts returned to High End Systems must be packaged in a suitable manner to ensure the protection of such Product unit or parts, and such package shall be clearly and prominently marked to indicate that the package contains returned Product units or parts and with an RMA number. Accompany all returned Product units or parts with a written explanation of the alleged problem or malfunction. Ship returned Product units or parts to: 2105 Gracy Farms Lane, Austin, TX 78758 USA.

Note: *Freight Damage Claims are invalid for fixtures shipped in non-factory boxes and packing materials.*

Freight

All shipping will be paid by the purchaser. Items under warranty shall have return shipping paid by the manufacturer only in the Continental United States. Under no circumstances will freight collect shipments be accepted. Prepaid shipping does not include rush expediting such as air freight. Air freight can be sent customer collect in the Continental United States.

REPAIR OR REPLACEMENT AS PROVIDED FOR UNDER THIS WARRANTY IS THE EXCLUSIVE REMEDY OF THE CONSUMER. HIGH END SYSTEMS, INC. MAKES NO WARRANTIES, EXPRESS OR IMPLIED, WITH RESPECT TO ANY PRODUCT, AND HIGH END SPECIFICALLY DISCLAIMS ANY WARRANTY OF MERCHANTABILITY OR FITNESS FOR A PARTICULAR PURPOSE. HIGH END SHALL NOT BE LIABLE FOR ANY INDIRECT, INCIDENTAL OR CONSEQUENTIAL DAMAGE, INCLUDING LOST PROFITS, SUSTAINED OR INCURRED IN CONNECTION WITH ANY PRODUCT OR CAUSED BY PRODUCT DEFECTS OR THE PARTIAL OR TOTAL FAILURE OF ANY PRODUCT REGARDLESS OF THE FORM OF ACTION, WHETHER IN CONTRACT, TORT (INCLUDING NEGLIGENCE), STRICT LIABILITY OR OTHERWISE, AND WHETHER OR NOT SUCH DAMAGE WAS FORESEEN OR UNFORESEEN.

Warranty is void if the product is misused, damaged, modified in any way, or for unauthorized repairs or parts. This warranty gives you specific legal rights, and you may also have other rights which vary from state to state.

Patents

This product may use one or more of the following patents: US 4,392,187; US 4,602,321; US 4,688,161; US 4,701,833; US 4,709,311; US 4,779,176; US 4,800,474; US 4,962,687; US 4,972,306; US 4,980,806; US 5,010,459; US 5,031,078; US 5,073,847; US 5,078,039; US 5,186,536; US 5,209,560; US 5,278,742; US 5,282,121; US5,307,295; US 5,329,431; US 5,331,822; US 5,367,444; US 5,402,326; US 5,430,629; US 5,432,691; US 5,454,477; US 5,455,748; US 5,506,762; US 5,515,254; US 5,537,303; US5,545,951; US 5,580,164; US 5,590,954; US 5,590,955; US 5,640,061; US 5,647,662; US5,665,305; US 5,691,886; US 5,728,994; US 5,758,955; US 5,758,956; US 5,769,527; US5,774,273; US 5,798,619; US 5,806,951; US 5,823,661; US 5,825,548; US5,828,485; US 5,829,868; US 5,857,768; US 5,882,107; US 5,934,794; US 5,940,204; US 5,945,786; US5,953,152; US 5,980,066; US 6,048,080; US 6,327,103; US 6,048,081; US 6,057,958; US6,054,816; US 6,126,288; US 6,142,652; US 6,172,822; US 6,188,933; US 6,208,087; US 6,219,093; US 6,220,730; US 6,241,366; US 6,255,787; US 6,256,136; US 6,278,542; US6,288,828; US 6,327,103; US 6,421,165; US 6,430,934; US 6,466,357; US 6,502,961; USD347,113; US D350,408; US D359,574; US D360,404; US D365,165; US D366,712; US D370,080; US D372,550; US D377,338; US D381,740; US D409,771; US 6693392; US 6719433; EP 0662275; EP 0767398; DE 621495; DE 655144; DE 797503; EP 0475082; GB 2 043 769 B; GB 2 055 842 B; GB 2 283 808 B; GB 2 290 134 B; GB 2 291 814 B; GB 2 292 530 B; GB 2 292 896 B; GB 2 294 909 B; GB 2 295 058 B; GB 2 303 203 B; GB 2 306 887 B; GB 2 307 036 B; GB 2 316 477 B; MR0862-1996; M9,604,224.9

Table of Contents

User Manual	i
Contacting High End Systems®	ii
Declaration of Conformity	iii
Important Safety Information	iv
FCC Information	iv
Safety Symbols	v
Warranty Information	v
Limited Warranty	v
Returning an Item Under Warranty for Repair	v
Freight	vi
Patents	vi

Chapter 1: Product Overview

Model Comparison	1
Studio Command™ Features	2
Fixture	2
All Models	2
Studio Command 1200/700 Model Only	2
Operation	2
Construction	3
Related Products and Accessories	4
Specifications	5
Mechanical	5
Environmental	5
Electrical	6
Power	6
Fuses	6
Cable and Connector Specifications	7
Lamp Specifications	7

Chapter 2: Setup and Configuration

Unpacking the Fixture	9
Installing an Attachment Plugs	9
Installing an Attachment Plug - U.K. Only	10
Vigtig Fikker Heds Information - Danmark	10
Installing the Lamp (Studio Command-H Fixtures Only)	10
Mounting the Fixture	11
Mounting the Fixture Upright	11

Mounting the Fixture on a Truss	11
Truss or Other Support System	12
Safety Cable	12
Clamp	12
Mounting Procedure	12
Linking the Fixtures	13
Data Cabling and Connectors	13
DMX data cables:	13
Cable Connectors:	14
Setting Up a DMX Link	15
Standalone Fixture Linking	16
Terminating the Link	16
Powering On the Fixture	17
Uploading Latest Fixture Software	17
Assigning a DMX Start Channel	18
Determining the DMX Start Channel	19

Chapter 3: The Menu System

On-Board Programming Capability	21
Navigating the Menu System	21
Studio Command Menu Options	22
Preset Menu (PRST)	23
Setting Preset Playback (PLAY)	23
Editing or Creating an On-Board Memory Scene (EDIT)	24
Copying an On-Board Memory Scene (COPY)	24
Capturing a Preset Scene (CAPT)	25
Enabling the Preset Default (DFLT)	25
Set Menu (SET)	26
Setting Factory Defaults (FACT)	26
Swapping Pan and Tilt (SWAP)	26
Inverting Tilt (T/IN)	27
Inverting Pan (P/IN)	27
Changing the Display Output (DSPL)	28
Inverting LED Characters (D/IN)	28
Setting the Lamp Warning Message (LMPL)	29
Data Loss Shutter Close (DLOS)	29
Mode Menu (MODE)	30
Setting the User Type (USER)	30
Copying User Presets (PRST)	30
Copying User Settings (SETT)	31
Copying User Presets and Settings (ALL)	31
Crossloading Fixture Software (XLD)	32

Test Menu (TEST)	33
Homing the Fixture (HOME)	33
Turning the Lamp On or Off (LAMP)	33
Copying the Boot Code (BOOT)	33
Performing Self Tests (SELF)	34
Placing the Fixture in Setup Mode (S/UP)	34
Testing the LED Display (DISP)	35
Changing Encoder Operation (ENCD)	35
Information Menu (INFO)	36
Viewing Sensor Information (SENS)	36
Viewing Fixture DMX Status and Parameter Values (FIXT)	37
Viewing DMX Data for Another Device (DATA)	38
Viewing the Current Logic Board Temperature (PCB)	39
Viewing the Current Fixture Head Temperature (HEAD)	39
Resetting Fixture Hours (F/RS)	40
Viewing the Current Fixture Hours (F/HR)	40
Resetting Lamp Hours (L/RS) (Studio Command 1200/700 models only)	40
Viewing the Number of Current Lamp Strikes (L/ST)	41
Viewing the Current Lamp Hours (L/HR)	41
Viewing the Current Software Version (VER)	41
Scene Creation, Looping and Playback Example	42
Step-by-Step Scene Creation	42
Creating a Loop	45
Playing Back a Loop	45
Synchronizing Preset Playback	46

Chapter 4: Fixture Programming

TalkBack™ Support for Remote Access	47
DMX Programming Overview	48
Full Speed versus MSpeed Control	48
DMX Programming Options	48
Programming with a DMX Console	48
DMX Programming Using the Onboard Menu System	49
Parameter Function Descriptions	49
Pan and Tilt Parameters	49
Color Function Parameter	49
Cyan, Magenta, and Yellow Parameters	50
Zoom Parameter	50
Shutter Function Parameter	50
Studio Command 1200/700 Models	50
Studio Command H Model	51
Dim Parameter	52

MSPeed (Motor Speed) Parameter	52
Macro Parameter	52
Control Parameter	53
Studio Command 1200/700	53
Studio Command H.....	53
Chapter 5: General Maintenance	
Replacing Parts	55
Replacing Fuses	55
Replacing the Lamp	58
Optimizing the Lamp	59
Motor Gear Maintenance	61
Chapter 6: Troubleshooting	
Alphanumeric Display Error Messages	63
Status LEDs	68
General Troubleshooting	69
Upload and Crossload Troubleshooting	71
Appendix A: Studio Command™ DMX Protocol	
Studio Command 1200 Protocol	73
Studio Command 700 Protocol	76
Studio Command-H Protocol	80
Appendix B: MSPeed Conversion Table.....	83
Appendix C: Important Safety Information	85
Appendice C: Importantes Informations Sur La Sécurité	87
Anhang C: Wichtige Hinweise Für Ihre Sicherheit	88
Apéndice C: Información Importante De Seguridad	89
Appendice C: Importanti Informazioni Di Sicurezza	90
Vigtig Sikkerhedsinformation	91
Appendix D: Menu Map	
Studio Command Menu Map	93

Chapter I:

Product Overview

The Studio Command Series offer powerful washlights featuring a large exiting beam with a compact head. All models use a patented lenticular array optical system to enhance the homogeneity of the projected light. The moving yoke fixtures feature an adjustable field angle from 18 to 32 degrees, and a CMY dichroic color-mixing system that provides rapid and quiet color changes.

Studio Command 1200 and 700 models use proven Philips long-life MSR lamps. These models also offer a variable mechanical and electronic strobe, boosted with the Light Burst™ effect, and a mechanical douser for smooth fade to black. The Studio Command 1200/700 models uses 14 channels on a DMX link.

The Studio Command H model offers a Tungsten source and works with standard theater dimming racks. The H model requires 13 DMX channels plus one channel dedicated to the dimmer.

All Studio Command fixtures provide an option for standalone programming and support **TalkBack™** technology that allows any DMX console supporting TalkBack protocol to remotely access the Studio Command onboard menu system.

Model Comparison

	Studio Command 1200	Studio Command 700	Studio Command H
Input Voltage	200-230 V	100-230 V	100-230 V
Lamp	1200 MSR*	700 MSR*	1000 W
Color Temperature	5900 K	5600 K	3200 K
Fixture Output	15,000 lumens	11,000 lumens	5,500 lumens

* 7200°K MSR 1200/2 and MSR 700/2 lamps are approved alternatives

Studio Command™ Features

Fixture

All Models

- 540° pan 240° tilt
- Optical encoders to automatically correct the beam's position if the fixture's head is jarred from its programmed position.
- Shutter construct parameters including ramp, snap, and synchronous strobing functions.
- Time code synchronization in stand-alone mode via master/slave links to any combination of xSpot® Xtreme, Technobeam®, Studio Spot®, Studio Color®, Studio Color® 250, Studio Spot® 250, Studio Beam®, and Studio Command™ fixtures.
- DMX analyzer for easy DMX troubleshooting.
- Lamp interlock douses the lamp if the lamp cap is opened while the lamp is on.
- Remote fixture power up and shut down.

Studio Command I200/700 Model Only

- Smooth full-field dimming without changing color temperature or beam shape.
- Electronic strobe in addition to a variable conventional strobe to 10 Hz.
- Full optical dimming and fade-to-black.
- Light burst lamp boosting and lightning effects.

Operation

- High-resolution DMX512 programming control.
- TalkBack protocol support for remote fixture control.
- Fat output beam (8 inches (200 mm) in diameter)
- Integral, fully variable zoom adjustable from 8°–13° beam angle and an 18°–32° field angle.
- Fully dichroic colors that never fade
- Full control over color mixing from smooth, stepless movement (allowing slow, imperceptible color fades) to rapid snap color changes
- Quiet performance even during snap color changes
- Even, soft-edged wash with good beam distribution for easy blending
- Live color fading from one color to another at any speed
- On-board Preset DMX programming via the fixture's menu system for stand-alone operation.
- Easy-to-program alphanumeric LED (light emitting diode) display.
- Two user Preset modes (A and B), each with an on-board 16-scene memory for a total of 32-scene memory per fixture in stand-alone mode.
- DMX macro channel factory-programmed with four Internal Effects™ macros.

Construction

- Exterior design minimizes light leakage.
- Universal power supply automatically selects the appropriate voltage for the fixture:
 - 200V–230V for Studio Command 1200
 - 100V–230V at 50-60 Hz for Studio Command 700 and Studio Command H models
- 5-pin XLR connectors. (Studio Command 1200/700 models also provide connections for 3-pin XLR data cables).
- Exclusive High End Systems, Inc. multi-phase technology for stunningly fast, smooth, and quiet yoke movement.
- LED status indicators streamline troubleshooting.
- Precision stepper motors control dimmer, shutter function, and color mixing.
- Compact and lightweight
- Color temperature control via an optional Gel Holder accessory.
- Studio Command H models provide a lamp to dimmer power cable for connection to standard theatrical dimmers.

Related Products and Accessories

The following table lists other products you can utilize with the Studio Command and optional accessories available from your High End Systems dealer/distributor.

Part Description	Part Number
MSR 1200 replacement lamp (5900K)	55030077
MSR 1200/2 alternative lamp (7200K)	55030047
MSR 700 replacement lamp (5600K)	55030069
MSR 700/2 alternative lamp (7200K)	55030048
1000 W, 100 V replacement Lamp for Studio Command H model	55030078
1000 W, 115 V replacement Lamp for Studio Command H model	55030071
1000 W, 230 V replacement Lamp for Studio Command H model	55030072
1000 W, 240 V replacement Lamp for Studio Command H model	55030079
Heavy duty 3-pin XLR cable (10')	55050005
Whole Hog [®] III Lighting Console	25020001
Hog iPC Lighting Console	74020001
Heavy duty 3-pin XLR cable (25')	55050006
Heavy duty 3-pin XLR cable (50')	55050007
Heavy duty 3-pin XLR cable (100')	55050008
Heavy duty 5-pin XLR cable (10')	55050017
Heavy duty 5-pin XLR cable (25')	55050018
Heavy duty 5-pin XLR cable (50')	55050019
Heavy duty 5-pin XLR cable (100')	55050020
Upload Dongle	26040002
Galvanized safety cable	12040001
Cheeseborough clamp	55040014
Gel Frame Holder accessory	78040001

For more information about optional accessories, contact either your High End Systems[®] dealer/distributor, High End Systems Sales, or visit the High End Systems Web site. For contact information, see *Contacting High End Systems[®]* on page ii.

Specifications

Mechanical

Dimensions: 352mm x 544mm x 526mm
13.9 in x 21.4 in x 20.7 in

Weight: 1200/700 Model - 24.9 kg (55 lbs)
H Model - 21.7 kg (48 lb)

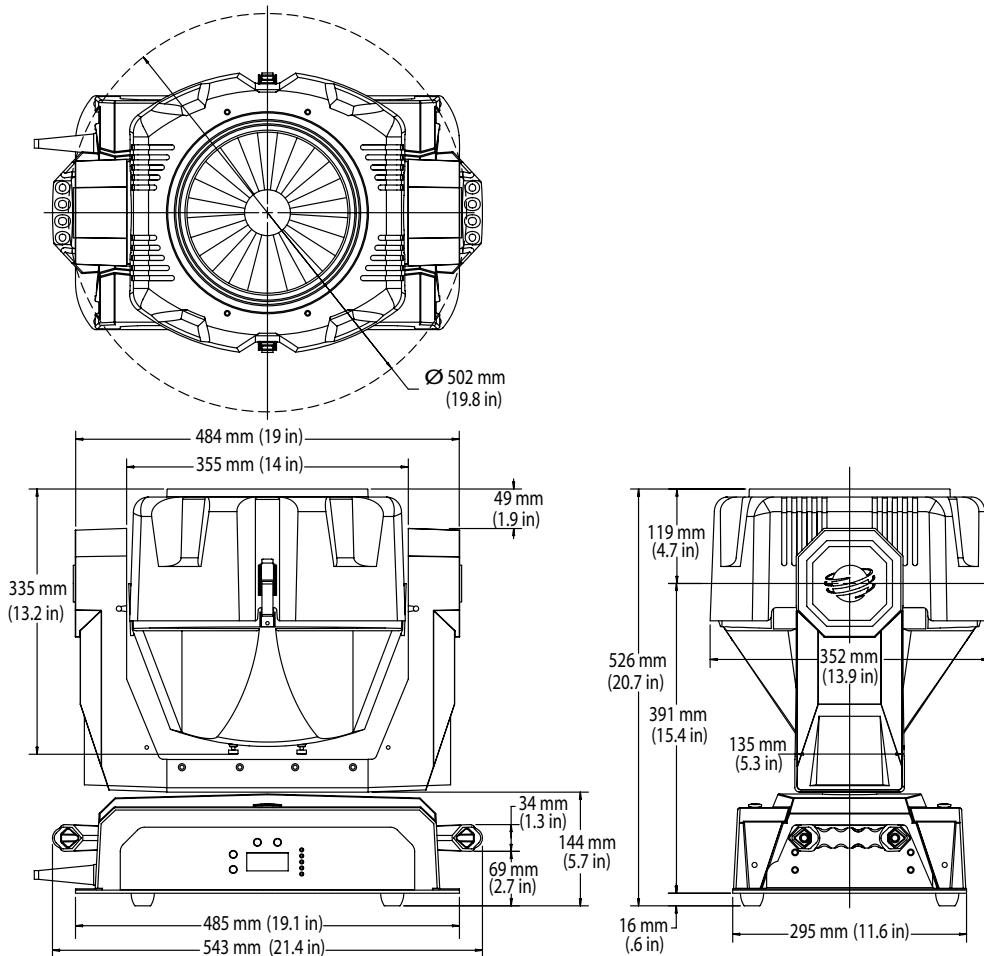

Environmental

Maximum ambient temperature, (T_a): 50° C (122° F)

Maximum exterior surface temperature: 160° C (320° F)



WARNINGS:

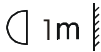

Minimum distance to flammable objects: 3.28 ft (1.0 m)



Minimum distance to lighted object: 6.56 ft (2.0 m)



Do not mount on a flammable surface.

Electrical

Power

Model	Maximum Rated Power	
Studio Command 1200	230 V @ 6.1 AMP	1400 W
Studio Command 700	230 V @ 4.3 AMP	1200 W
Studio Command H	230 V @ 5.2 AMP*	1200 W

* Total fixture and dimmer controlled lamp

Fuses

Logic Board Fuses:

F1 - 2.5A, 250V, Slow Blow only (5 mm x 20 mm)

F2 - 2.5A, 250V, Slow Blow only (5 mm x 20 mm)

Motor Power Supply Fuses:

F1 - 6.3A, 250V, Slow Blow only (5 mm x 20 mm)

F2 - 6.3A, 250V, Fast Blow only (5 mm x 20 mm)

Filter Board Fuses:

F1 - 16A, 250V, Fast Blow only (5 mm x 20 mm)

F2 - 16A, 250V, Fast Blow only (5 mm x 20 mm)

Voltage Surge: A surge of 2000V or more may damage the power supply.



Warning: Class 1 equipment - This equipment must be earthed.

Cable and Connector Specifications

DMX data cables: Belden® 9841 or equivalent (meets specifications for EIA RS-485 applications) with the following characteristics:

- 2-conductor twisted pair plus a shield
- maximum capacitance between conductors - 30 pF/ft.
- maximum capacitance between conductor and shield - 55 pF/ft.
- maximum resistance of 20Ω / 1000 ft.
- nominal impedance 100-140Ω

DMX data connectors, 1200/700 Model: 3-pin or 5-pin male and female XLR connectors

DMX data connectors, H Model: 5-pin male and female XLR connectors

DMX data terminators: Male XLR connector with 120 ohm terminator

Lamp Specifications

	Studio Command 1200		Studio Command 700		Studio Command H
	<i>Primary Lamp</i>	<i>Alternate Lamp</i>	<i>Primary Lamp</i>	<i>Alternate Lamp</i>	
Lamp:	PHILIPS MSR1200	PHILIPS MSR1200/2	PHILIPS MSR700	PHILIPS MSR700/2	PHILIPS 7002 Y
Luminous Flux	110,000lm	110,000lm	56000lm	55000 lm	29,000 lm
Arc Length	10 mm	10 mm	8 mm	8 mm	N/A
Color Temperature	5900 K	7200 K	5600 K	7200 K	3200 K
Lamp Life 50%	800 hrs	800 hrs	1000 hrs	1000 hrs	250 hrs
CRI	95	85	95	80	100
CIE	X=.325; Y=.320	X=.302; Y=.320	X=.330; Y=.330	X=.302; Y=.320	

Chapter 2:

Setup and Configuration

Unpacking the Fixture

Unpack your Studio Command™ fixture and verify that it arrived undamaged. Inspect both the outside of the fixture for physical damage and the inside of the fixture for damage to glass components.

To access the internal components, release the two bezel latches (one latch located on each side of the fixture's head) and remove the bezel.

If the fixture is damaged, notify both the shipping agent and your sales agent immediately.

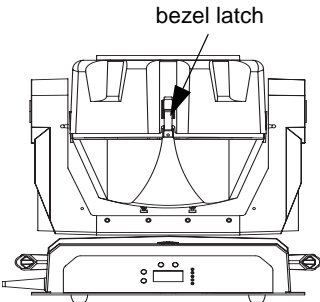

Do not discard the shipping carton and packing materials. The carton and packing materials are specifically designed to protect the product during transport.

High End Systems assumes no responsibility for products that are damaged during transport. Always return a product for repair in its original shipping carton and packing materials.

Note: *Before sending anything to the factory, call your High End Systems dealer/distributor for a Return Material Authorization (RMA) number. The factory cannot accept any goods shipped without an RMA number.*

Installing an Attachment Plugs

Studio Command fixtures do not ship with molded attachment plugs on the fixture power cable and, in the case of Studio Command-H fixtures, the dimmer power cable. Different locations (even within the same country) may require a different attachment plug to connect your fixture to a power outlet. Because of the variety of attachment plugs used worldwide, High End Systems, Inc. cannot make specific recommendations for the particular attachment plug you should use. Contact a local authority if you are unsure which type of attachment plug you need to obtain. Note that the cores in the mains lead are colored according to the following code:

- green and yellow = earth
- blue = neutral
- brown = live



Warning: Class 1 equipment - This equipment must be earthed.

Installing an Attachment Plug - U.K. Only



In the United Kingdom, the colours of the cores in the mains lead of this equipment may not correspond with the colored markings identifying the terminals in your plug. Therefore, install an attachment plug in accordance with the following code:

- The core which is coloured green and yellow must be connected to the plug terminal which is marked with the letter “E” or by the earth symbol , or coloured green, or green/yellow.
- The core which is coloured blue must be connected to the terminal which is marked with the letter “N” or coloured black.
- The core which is coloured brown must be connected to the terminal which is marked with the “lateral” or coloured red.

Vigtig Fikker Heds Information - Danmark

Advarsel: Beskyttelse mod elektrisk chock.

Vigtigt!

Lederne med gul/groen isolation maa kun tilsluttes en klemme maerket  eller 

Installing the Lamp (Studio Command-H Fixtures Only)

1. Tilt the fixture's head to access the lamp cap and using a wide tip, flat head screwdriver, loosen (but do not remove) the two lamp assembly screws.
2. Pull the lamp assembly straight out of the fixture. The lamp assembly is connected to the fixture by lamp socket wires. Support the lamp assembly while replacing the lamp. **Do not allow the lamp socket wires to support the weight of the lamp assembly.**
3. Remove all packaging materials from the new lamp. Holding the new lamp by its ceramic base, gently press the two base pins into the lamp socket until the lamp is firmly seated.

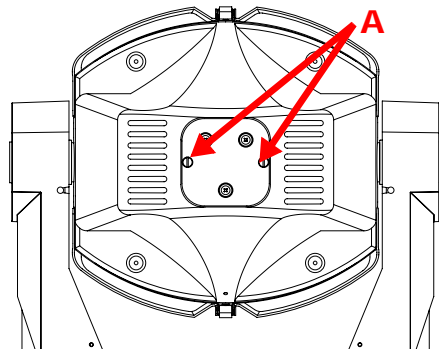

Caution: When handling the new lamp, avoid contact with the lamp glass. If the lamp glass is soiled by oil or dirt from skin, gloves, etc., clean the cold lamp glass with an alcohol wipe. A soiled lamp could overheat and burst, causing damage to the fixture.

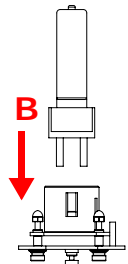

4. Insert the lamp assembly straight into the fixture and re-tighten the lamp cover screws.



Caution: Make sure the lamp socket wires are not wrapped around the lamp or crimped while reinserting the lamp assembly

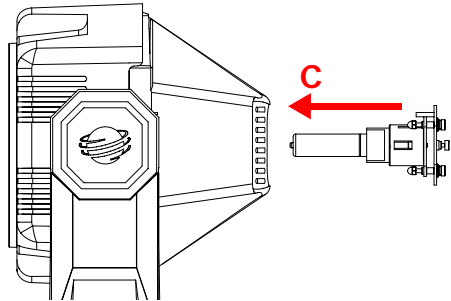

Mounting the Fixture



Warnings: Equipment suitable for dry locations only. Do not expose this equipment to rain or moisture.

Do not mount on a flammable surface.

Use a secondary safety cable when mounting this fixture.



Maintain a minimum distance of 1 m (3.28 ft.) from combustible materials.



Maintain a minimum distance of 2 m (6.56 ft.) from lighted object. This means the fixture must be positioned at least 2 meters away from the object it is illuminating.

You can mount Studio Command fixtures either upright (on the fixture's base) or in any orientation suspended from a support system (such as a truss). Follow the instructions below for the mounting orientation you choose.

Mounting the Fixture Upright

To mount the fixture upright, make sure that all four rubber feet are installed on the fixture's base and place the fixture on a sturdy, stable surface.

If the surface is above floor height, use safety cables to secure the fixture to the surface. Install the safety cable(s) by looping the cables around a support on the surface, through the side holes in the fixture's base, and around the fixture's handles. Make sure the support and cables can support the weight of the fixture 1200/700 Model - 24.9 kg (55 lbs) H Model - 21.7 kg (48 lb).



Caution: Do not mount the fixture upright without the four rubber feet installed.

Mounting the Fixture on a Truss

You will need:

- truss or other support system
- safety cables (2)
- clamps (2)

- locking washers (2)

Truss or Other Support System

If you are mounting the fixture(s) on a truss or another type of support, verify that the truss or support will handle the weight of *all* the devices you are mounting. The Studio Command fixture weighs 1200/700 Model - 24.9 kg (55 lbs) H Model - 21.7 kg (48 lb).

Safety Cable

High End Systems strongly recommends that you use a safety cable when mounting any fixture. You must supply your own safety cable and verify that the cable is capable of supporting the weight of the fixture. You can order galvanized safety cables from your High End Systems dealer/distributor (see *Related Products and Accessories* on page 4).

Clamp

You must supply your own clamps and verify the clamp is capable of supporting the weight of the fixture. You can order deluxe C-clamps for a two-inch truss from your High End Systems dealer/distributor (see *Related Products and Accessories* on page 4).

Mounting Procedure

Note: *Due to the wide variety of possible lighting designs, High End Systems cannot make specific mounting recommendations. Consider the following procedure as a suggested guideline only.*

To mount Studio Command fixtures on a truss:

1. Disconnect power to the fixture. If the fixture has been operating, allow the fixture to cool before handling.
2. Always stand on a firm, stable surface when mounting a fixture to its support. The fixture should be at a height where you can comfortably work on it, and should either be resting on a stable surface, or held securely.
3. Attach suitable clamps through the center holes on the base of the fixture. *Install two locking washers per clamp when attaching the clamps to the fixture's base.*
4. Tighten the clamps firmly to the fixture's base and to the support.
5. Loop one or more suitable safety cables around the support, through the side holes in the fixture's base, and around the fixture's handles.

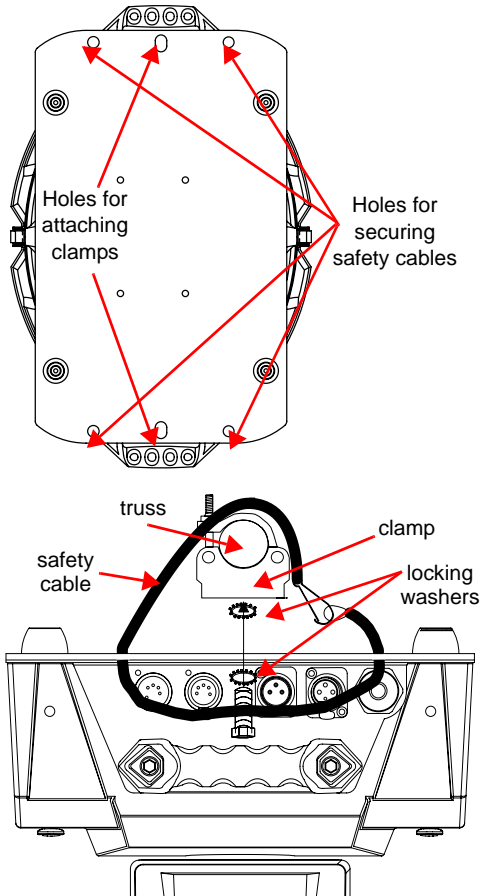

Linking the Fixtures

The combined number of channels required by all the fixtures on a DMX 512 link determines the number of fixtures the link can support. Each Studio Command fixture uses 14 channels on a DMX512 link.

Studio Command-H fixtures use 13 channels plus a channel dedicated to a dimmer.

Note: *If you connect more than 32 fixtures to a link, you must use a DMX splitter. The 32 device limit complies with the EIA-485 standard. Connecting more than 32 devices per link without a DMX splitter will eventually deteriorate the digital signal.*

Controllers, serial data distributors, data line optoisolators, and any fixtures using the RS-422 DMX standard of serial communications block software uploads, crossloads, or TalkBack™ protocol on a link. Therefore, make sure you either put all of these devices after the Studio Command fixture on the link, or bypass these devices when you perform software uploads or crossloads

Data Cabling and Connectors

To link one or more fixtures to a controller and/or to each other, you must obtain data cabling. You can either purchase cabling from High End Systems (see *Related Products and Accessories* on page 4) or construct your own cabling.

If you choose to construct cabling, High End Systems recommends that you use data-grade cable. Data-grade cable is designed to carry a high-quality signal with less susceptibility to electromagnetic interference.

DMX data cables:

Belden® 9841 or equivalent (meets specifications for EIA RS-485 applications) with the following characteristics:

- 2-conductor twisted pair plus a shield
- maximum capacitance between conductors - 30 pF/ft.
- maximum capacitance between conductor and shield - 55 pF/ft.
- maximum resistance of 20Ω / 1000 ft.
- nominal impedance 100-140Ω

Cable Connectors:

Studio Command 1200/700 fixtures can accept either 3-pin or 5-pin XLR cable connectors. Studio Command H fixtures use 3-pin XLR cable connectors only. Cabling must have a male XLR connector on one end of the cable and a female XLR connector on the other end. The following diagram shows the pin configuration for both cable types.

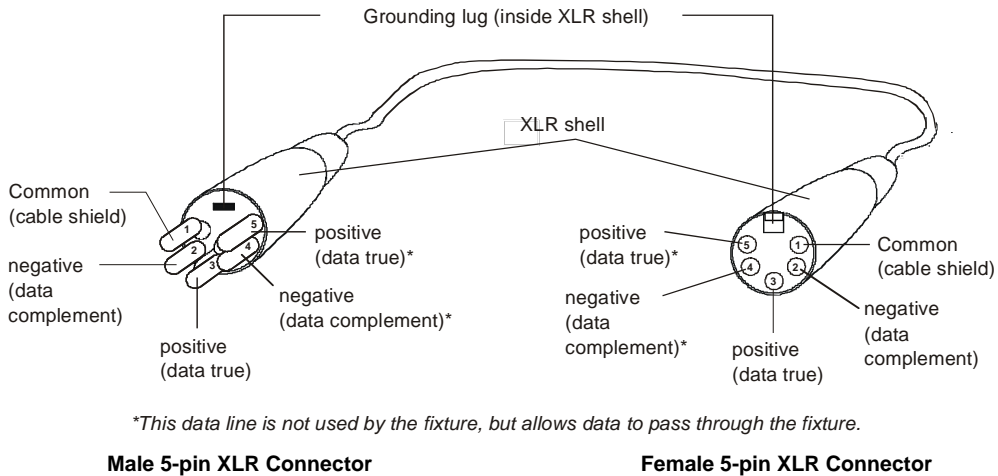
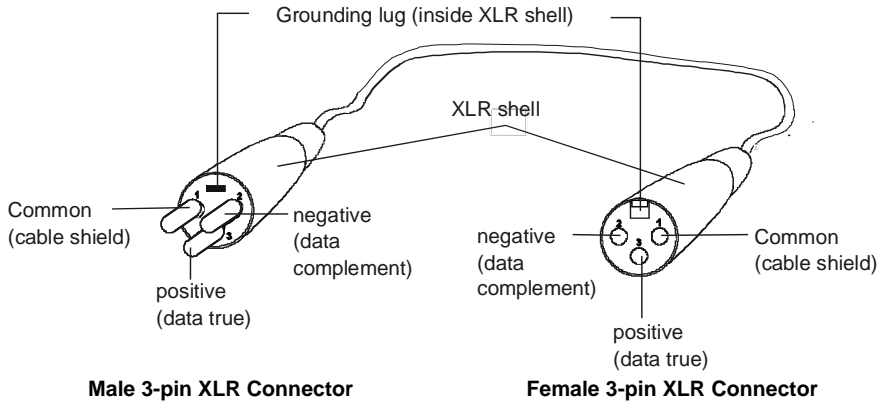

**This data line is not used by the fixture, but allows data to pass through the fixture.*

Pin configuration for 3-pin (Studio Command 1200/700 model only) and 5-pin XLR cables

Test each cable with a voltage/ohm meter (VOM) to verify correct polarity and to make sure that the negative and positive pins are not grounded or shorted to the shield or to each other.



Caution: Do not connect anything to the ground lug on the XLR connectors. Do not connect or allow contact between the common (cable shield) and the fixture's chassis ground. Grounding the common could cause a ground loop and/or erratic behavior.

Setting Up a DMX Link

To link one or more fixtures to a controller using either 3-pin or 5-pin XLR cables:

1. Connect the male XLR connector of a DMX Data cable to the controller's DMX Data Out connector.
2. Connect the Data cable's female XLR connector to the Data In connector of the first (or next) fixture on the DMX link.
3. Continue linking the remaining fixtures connecting a cable from the Data Out connector of each fixture to the Data In connector of the next fixture on the link.
4. Connect a male terminator to the Data Out connector of the last fixture in the link. For information on obtaining a terminator, see *Related Products and Accessories* on page 4.

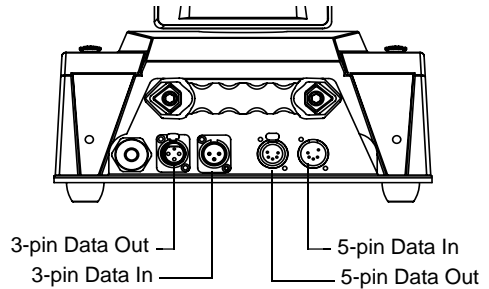

Data cable connectors on the Studio Command® 1200/700 fixture panel

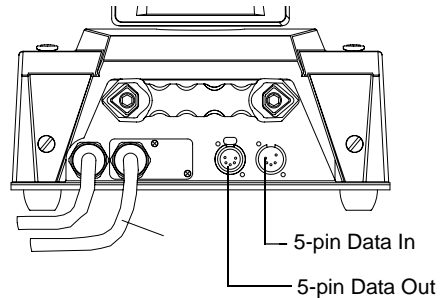

Data cable connectors on the Studio Command® H fixture panel

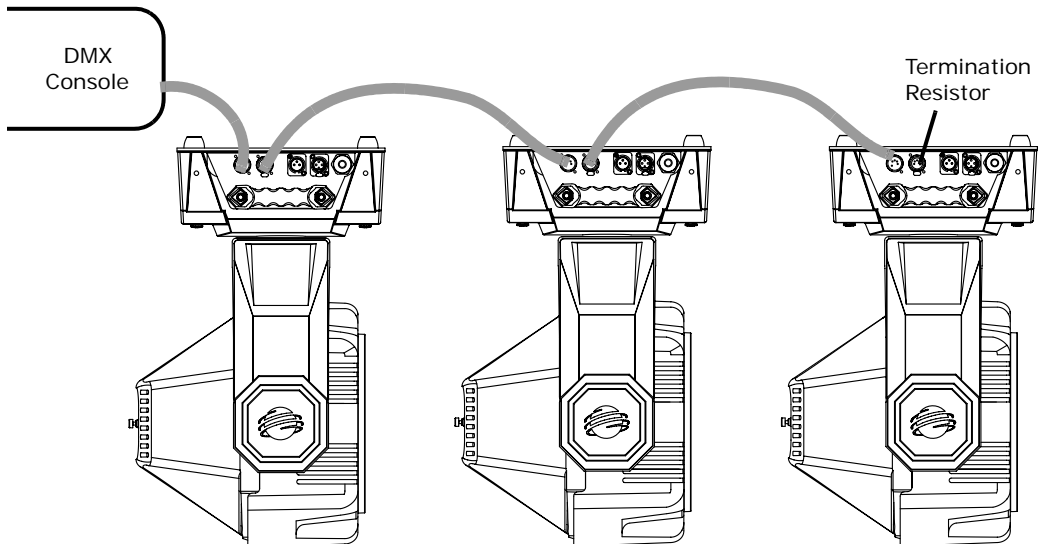

Connecting to a DMX link using 5-pin connectors

Standalone Fixture Linking

To link one or more fixtures to a controller using either 3-pin or 5-pin XLR cables:

1. Connect the male XLR connector of a DMX Data cable to the Data Out connector on the fixture addressed at DMX Start channel 1.
2. Connect the cable's female XLR connector to the Data In connector of the next fixture on the DMX link.
3. Continue linking the remaining fixtures connecting a cable from the Data Out connector of each fixture to the Data In connector of the next fixture on the link.
4. Connect a male terminator to the Data Out connector of the last fixture in the link. For information on obtaining a terminator, see the following section.

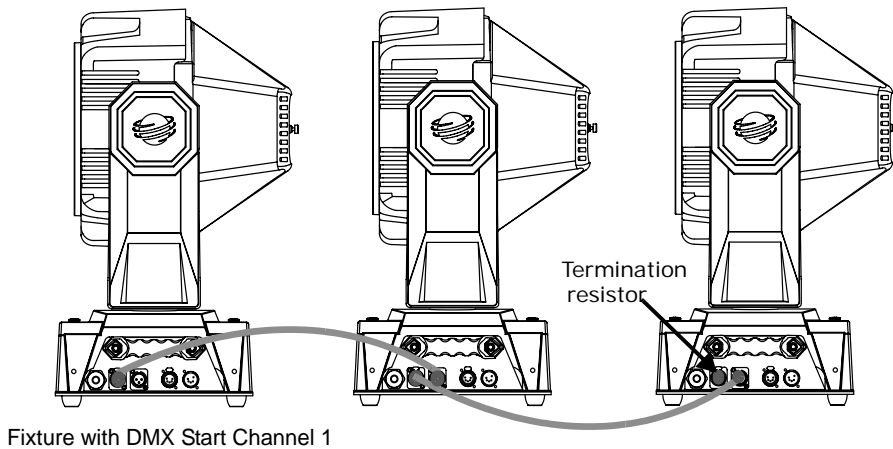

Linking without a controller using 5-pin data cables



Caution: Do *not* connect more than one Data In and one Data Out connector to each fixture.

Terminating the Link

You must install a 120 ohm, 1/4 watt (minimum) terminator in the fixture's Data Out (female) cable connector in the *last* fixture on each DMX link. If you plan to control your fixtures in stand-alone mode (with no controller on the link), you must also install a female terminator in the Data In cable connector on the *master* fixture (the fixture assigned to DMX start channel 1). A terminator will prevent data reflection, which can corrupt the data communication on the link.

Use the following steps to construct a terminator:

1. Obtain and disassemble a 3-pin or 5-pin XLR connector.
2. Solder a 120 ohm resistor, minimum of 1/4 watt, between pins two and three.
3. Reassemble the XLR connector.

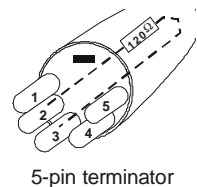
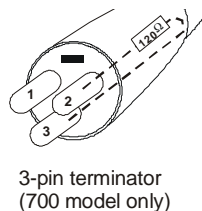

Powering On the Fixture



Warning: This equipment is designed for connection to a branch circuit having a maximum overload protection of 20 A.



Studio Command-H Fixtures Only

Caution: To preserve lamp life, reduce lamp power through the dimmer rack controls while powering and homing the fixture. This will reduce voltage inrush to the lamp when the relay contacts close at the completion of the homing operation. When operating the luminaire with the lamp on, the head bezels must be installed for proper head cooling and temperature control.

Studio Command fixtures do not have a power switch. To power on the fixture, simply connect it to an appropriately-rated power source. Once connected, you can remotely power up or shutdown the fixture via controller commands (see *Control Parameter* on page 53). However, it is very important that you disconnect power to the fixture before performing certain procedures shown in this manual.

When you connect any Studio Command to an appropriately-rated power source, the fixture automatically begins a homing procedure. You can also remotely home the fixture via a DMX controller (see *Control Parameter* on page 53) or manually home the fixture via the on-board menu system (see *Homing the Fixture (HOME)* on page 33).

The fixture's homing procedure verifies that the major functions of the fixture (color wheels, frost flags, and shutter) are correctly oriented. The homing procedure is also used to take the fixture out of shutdown mode. During the homing process, you will hear clicking sounds as the wheels, flags, and shutter seek their home position.

Uploading Latest Fixture Software

The latest software for Studio Command fixtures is available in the support section of the HighEnd Systems web site (www.highend.com/support). There are two ways to upload new software to Studio Command fixtures:

1. Attach a High End Systems Upload Dongle to your computer and upload the software to your Studio Command fixture using WinUpload software (Version 1.1 or higher).

WinUpload software requires a computer running Microsoft® Windows® 95, 98, ME, XP, or 2000 operating system. To Install the WinUpload Software, create a WinUpload folder on your hard drive. Download the Upload Module from www.highend.com/support page for your product and copy the WinUpload.exe and inport32.dll files into the folder on your hard drive.

2. Crossload software from one fixture that contains the new software to all other Studio Command fixtures on the link, (see *Crossloading Fixture Software (XLD)* on page 32.

Note: Before you can upload new software, you must disconnect any controllers, bypass any serial data distributors and/or data line optoisolators, and bypass or make sure that any fixtures using RS-422 communications (such as Dataflash® AF1000 xenon strobes, and Intellabeam® fixtures) are located after the Studio Command fixtures on the link. These devices will block communication with any other Studio Command fixtures on the link.

Assigning a DMX Start Channel

The DMX start channel identifies each fixture on a DMX link. If you plan to control your fixtures with a DMX console (or using synchronized preset playback), you must assign a DMX start channel to each fixture on the link.

If you *always* plan to use the fixture in stand-alone mode (without a controller or synchronized preset playback), you can skip this section.

There are 512 available channels on each DMX link. These 512 channels are divided among *all* the devices on a particular link. The number of channels a fixture requires on the link is the fixture's channel range. Studio Command fixtures require a 14-channel range. The DMX start channel is the first channel available to a fixture in its channel range.

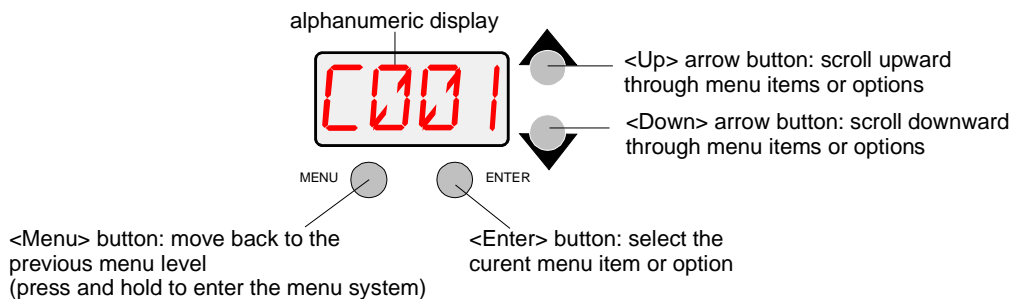

To assign a DMX start channel, access the fixture's menu system via the alphanumeric LED display and four menu navigation buttons on the fixture's front panel.



The fixture's channel range must not overlap any other device's channel range on the link.* When two devices on the same DMX link have overlapping channel ranges, one or both devices will be disabled or behave erratically.

***Note:** The single exception to the non-overlapping rule is if you want the fixtures to respond to controller commands in exactly the same way. In this case, the fixtures must be the same type (for example, two Studio Command fixtures) and the fixtures must share the entire channel range.

To assign the start channel:

1.  Press and hold <Menu> until *Addr* appears on the LED display. Press <Enter> to select.
2.  Scroll to the desired DMX start channel (*C001– C512*)
to
3.  Press <Enter> to store selection.

Determining the DMX Start Channel

This section describes how to determine start channels for the fixtures on a DMX link if you plan to mix different fixture types (for example, a Studio Command fixture and a Studio Spot 250 fixture) on the same DMX link.

To determine each fixture's DMX start channel in a link, you must know the number of channels used by each fixture. Knowing that the first fixture on the link will use DMX start channel 1, you can determine the DMX start channel for each successive fixture by adding the number of DMX channels used by the fixture to the fixture's DMX start channel. For example, in the following table, 14 (channels used by Studio Command running) + 1 (DMX start channel for the first fixture) = 14 (DMX start channel for the next fixture on the link).

Fixture location on the link	Fixture name	Number of DMX channels used per fixture	DMX start channel	Channel range used
First	Studio Command 1200/700	14 channels	C001	1-14
Second	Other Fixture	9 channels	C015	15-23
Third	Studio Command -H	13 channels	C024	24-36
Fourth	Dimmer required for Studio Command-H	1 channel	C037	37

Note: *The fixture location on the link does not have to comply with this example. The fixtures can be addressed in any order on the link. The maximum Start channel for the last Studio Command fixture on a DMX512 link is 498 (channel range 498-512).*

Note: *If you connect more than 32 fixtures to a link, you must use a DMX splitter. The 32 device limit complies with the EIA-485 standard. Connecting more than 32 devices per link without a DMX splitter will eventually deteriorate the digital signal.*

Chapter 3:

The Menu System

On-Board Programming Capability

When you use the fixture's on-board menu system to program the Studio Command™ fixture, you manually assign a value to each of the fixture's available parameters.

The onboard Studio Command menu system allows you to:

- Assign a DMX start channel.
- Access fixture options such as homing the fixture, viewing fixture status, crossloading software, and performing self tests.
- Create, store, and play scenes from the fixture's on-board memory.

For a full menu map of the Studio Command menu system, see *Appendix D: Menu Map*.

Note: *The same Menu system is used on all models. Some options may not function for Studio Command H fixtures.*

Navigating the Menu System

Access the menu system via the four menu navigation buttons on the fixture's front panel.

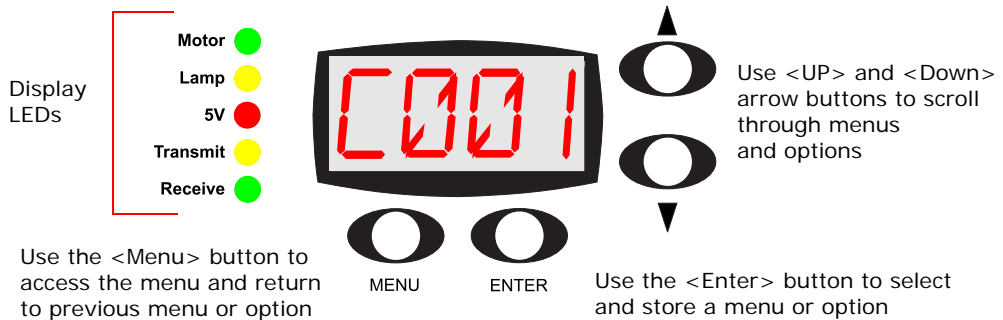

Menu navigation buttons.

The alphanumeric LED display shows the menu items you select from the menu map. When accessing fixture options (not preset scenes), the display will flash when a new option is *selected* (by pressing the <Up> or <Down> arrow buttons) and stops flashing when a new option is *stored* (by pressing the <Enter> button).

To access the menu system, press and hold the <Menu> button until *AddR* appears on the display. The menu system is protected against inadvertent menu changes by requiring the <Menu> button to be held for a few seconds before allowing entry to the menu system.

To return to the previous option or menu *without changing the value*, press the <Menu> button.

To exit the menu system, keep pressing the <Menu> button until *MENU* appears on the display. *MENU* is replaced, after a few seconds, with the default display cycling the fixture's software version, fixture type, and DMX start channel.

Note: *After you have accessed the menu system, the words **AUTO** and **LOCK** appear briefly on the display after **TOP** as the fixture's software is locking the display.*

Studio Command Menu Options

The sections below explain how to access the fixture options shown in the fixture's menu map. This manual uses the following conventions in the descriptions for menus and menu navigation buttons:

Example	Meaning
<Button>	Press the appropriate LED display navigation button on the fixture. For example, the <Enter> button on the LED display panel.
Menu Option	Italics are used to indicate the appropriate menu selection you should choose from the on-board menu system. For example, the <i>AddR</i> menu option.

Address Menu (AddR)

The DMX start channel identifies each fixture on a DMX link. If you plan to control your fixtures with a DMX console (or using synchronized preset playback), you must assign a DMX start channel to each fixture on the link.

The Address menu allows you to change the DMX start channel that is currently assigned to the fixture. Be sure you do not overlap fixture channel ranges when changing the DMX start channel. For more information, see *Determining the DMX Start Channel* on page 19.

To change the DMX start channel:



1. Press and hold <Menu> until *AddR* appears on the LED display. Press <Enter> to select.

to

2. Select a new DMX start channel (*C001–C497*). The LED display flashes when a new option is selected.



3. Press <Enter> to accept the new DMX start channel. The LED display stops flashing when a new option is entered. If you do not press <Enter>, the new option you selected is not stored.

Preset Menu (PRST)

Studio Command fixtures have 16 preset scenes for each of two user modes (A and B) for a total of 32 preset scenes. Some Preset menu options can be accessed for either user mode. However, you must *first* set the fixture to User A or User B. For more information, see *Setting the User Type (USER)* on page 30.

The Preset menu allows you to turn preset playback off or on, view which scene is currently playing, create/edit a scene using the on-board memory to program the fixture for standalone operation, copy a scene from the on-board memory to another scene, and capture a scene from your DMX console to the on-board memory. This menu also allows you to enable the factory-programmed preset sequence.







For a detailed example of using Preset programming for Scene creation, Looping and Synchronizing Playback, see *page 42*.

Setting Preset Playback (PLAY)

This menu option allows you to view which scene is currently playing in preset playback mode or turn preset playback on or off. Before using this menu option, you need to have the user mode for the desired scene already selected, see *Setting the User Type (USER)* on page 30.

Note: *Scene 1 must be programmed before the fixture can play back scenes.*





To set Preset Playback on or off, or to view the current scene:

-  1. Press and hold <Menu> until *AddR* appears on the LED display.
-  2. Scroll to the *PRST* menu and press <Enter> to select.
-  3. Scroll to the *PLAY* menu (this will be the first menu displayed). Press <Enter> to select.
- 
or

or
 4. Scroll to *ON* to set preset playback on, *OFF* to set preset playback off, or *SCN* to display which scene is currently playing.
5. Press <Enter> to store selection.

Editing or Creating an On-Board Memory Scene (EDIT)

This menu item allows you to select a scene to edit or create using the fixture's on-board scene memory. To use this menu option you need to have the user mode for the desired scene already selected, see *Setting the User Type (USER)* on page 30.

To select a scene to create or edit:









-  1. Press and hold <Menu> until AddR appears on the LED display.
-  2. Scroll to the PRST menu. Press <Enter> to select.
-  3. Scroll to the EDIT menu. Press <Enter> to select.
-  4. Scroll to the scene you want to create or edit (SN01–SN16).
-  5. Press <Enter> to store.

After a scene is selected, the value of any parameter for that scene can be changed. *Step-by-Step Scene Creation* on page 42 contains a detailed example of modifying scene parameters.

Copying an On-Board Memory Scene (COPY)

Use the Copy menu option to copy the settings for a source scene to a destination scene location. This menu option will copy between any of the 32 scene locations available.

To Copy a Memory Scene from one location to another:





-  1. Press and hold <Menu> until AddR appears on the LED display.
-  2. Scroll to the PRST menu. Press <Enter> to select.
-  3. Scroll to the COPY menu. Press <Enter> to select.
-  4. The LED will display FROM. Press <Enter> to select.
-  5. Scroll to the scene you want to copy from (source scene) for either User A (FA01–FA16) or user B (FB01–FB16). This example indicates From User A Scene 01
-  6. Press <Enter>. The LED will display TO. Press <Enter> to select.
-  7. Scroll to the scene you want to copy to (destination scene) for either User A (TA01–TA16) or user B (TB01–TB16). This example indicates To user B Scene 16
-  8. Press <Enter>. The fixture copies the desired scene to the selected scene location. When the copy is complete, dONE will appear briefly in the fixture's LED display.

Capturing a Preset Scene (CAPT)

Preset capturing is a way to automate the creation of scenes on multiple Studio Command fixtures connected to a DMX 512 link. Use a DMX console to create a scene, then save (capture) the scene into a fixture's presets to play back the scene without the console. When capturing a scene into a fixture's presets, all parameter values must be constant (i.e., there cannot be any pan/tilt movement or scene-to-scene sequencing). This menu option can be accessed for User Type A or B (see *Setting the User Type (USER)* on page 30).

Note: You must use the fixture's on-board scene memory to manually select values for the *XFAD* and *DLAY* parameters, since a DMX console will not transmit those parameter values.





After creating a scene with your DMX console, follow the instructions below for each fixture on which you want to capture preset scenes:

-  1. Press and hold <Menu> until *AddR* appears on the LED display.
-  2. Scroll to the *PRST* menu. Press <Enter> to select.
-  3. Scroll to the *CAPT* menu. Press <Enter> to select.
-  4. Scroll to the scene you want to copy the preset scene to (destination scene) (*SN01–SN16*). Press <Enter>. The fixture will copy the DMX-512 console's preset scene to the selected scene on your fixture's on-board 16 scene memory for either User A or User B.
-  5. When the fixture finishes the capture successfully, *DONE* will appear briefly in the fixture's LED display.

Enabling the Preset Default (DFLT)

Enabling the Preset Default reverts all programming back to the factory-programmed preset default sequence. This menu option can be accessed for either User type A or User type B. However, you must *first* set the fixture to the desired user type. To retain pre-programmed scenes you do not wish to erase, set the fixture to one user type and then enable the preset default for the *other* user type (see *Setting the User Type (USER)* on page 30).

To enable the Preset Default:

-  1. Press and hold <Menu> until *AddR* appears on the LED display.
-  2. Scroll to the *PRST* menu and Press <Enter> to select.
-  3. Scroll to the *dFLT* menu and Press <Enter> to select.
-  4. The LED display will show *OK?* Press <Enter>. The fixture plays the default sequence continuously until you press <Menu>.

Note: To play the fixture's default sequence, preset playback must be ON (see *Setting Preset Playback (PLAY)* on page 23.)

Set Menu (SET)

The Set menu allows you to lock the fixture, and either set all factory options to their default settings or access and change the factory options individually. The procedures below are listed in the same order shown on the menu map (see *Appendix D: Menu Map*).





Setting Factory Defaults (FACT)

When you set this menu item on, all factory options return to their default settings. Studio Command fixtures are shipped from the factory with the following default option settings:

pan/tilt swap = off	LED display = on and bright	shutter close with DMX data loss = short
tilt invert = off	LED display invert = off	fast pan/tilt movement = off
pan invert = off	lamp life warning = off	preset playback = off





Note: To change the preset playback option, see **Setting Preset Playback (PLAY)** on page 23.

The factory default menu option displays *On* if all the factory options are at the factory default settings. If any of the items listed above are not at the factory default setting, the display reads *OFF*. Selecting the *OFF* option will have no effect. To restore the factory default setting:

-  1. Press and hold <Menu> until *AddR* appears on the LED display.
-  2. Scroll to the *SET* menu. Press <Enter> to select.
-  3. Scroll to the *FACT* menu (this will be the first menu displayed). Press <Enter>.
-  4. Scroll to *ON* to restore the factory option defaults.
5. Press <Enter> to store.

Swapping Pan and Tilt (SWAP)

This menu option swaps the pan motor and tilt motor operation to allow fixtures hung perpendicular to each other to respond to pan and tilt movement commands in the same direction. To swap pan and tilt motion:

-  1. Press and hold <Menu> until *AddR* appears on the LED display.
-  2. Scroll to the *SET* menu. Press <Enter> to select.
-  3. Scroll to the *SWAP* menu. Press <Enter> to select.
-  4. Scroll to *ON* to swap the fixture's pan and tilt motion, or *OFF* to return the fixture's pan and tilt motion to normal orientation.
5. Press <Enter> to store.

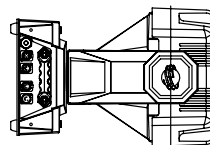
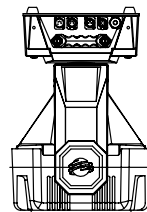

Fixture hung perpendicular to each other

Inverting Tilt (T/IN)

This menu item inverts the direction of the tilt motor, to allow fixtures mounted opposite each other vertically to respond to tilt movement commands in the same direction.

To invert the fixture's tilt motion:

1. Press and hold <Menu> until *AddR* appears on the LED display.
2. Scroll to the *SET* menu. Press <Enter> to select.
3. Scroll to the *T/IN* menu. Press <Enter> to select.
4. Scroll to *ON* to invert the fixture's tilt motion, or *OFF* to return the fixture's tilt motion to normal orientation.
5. Press <Enter> to store.

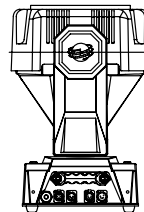
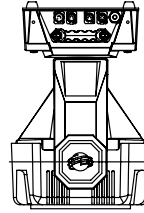

Vertically opposing fixtures

Inverting Pan (P/IN)

This menu item inverts the direction of the pan motor, to allow fixtures mounted opposite each other horizontally to respond to pan movement commands in the same direction.

To invert the fixture's pan motion:

1. Press and hold <Menu> until *AddR* appears on the LED display.
2. Scroll to the *SET* menu. Press <Enter> to select.
3. Scroll to the *P/IN* menu. Press <Enter> to select.
4. Scroll to *ON* to invert the fixture's pan motion, or *OFF* to return the fixture's pan motion to normal orientation.
5. Press <Enter> to store.

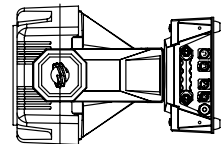
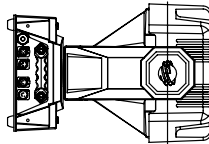







Horizontally opposing fixtures

Changing the Display Output (DSPL)





You can manually change the appearance of the fixture's alphanumeric LED display, setting the display on or off, or dimming the display to reduce visibility. If you want to remotely change the display output (using a DMX console), see *Control Parameter* on page 53.

To change the display output:

-  1. Press and hold <Menu> until *AddR* appears on the LED display.
-  2. Scroll to the *SET* menu. Press <Enter> to select.
-  3. Scroll to the *DSPL* menu. Press <Enter> to select.
- 
or

- 
or
 5. Press <Enter>.

Inverting LED Characters (D/IN)

To invert the orientation of the LED display's alphanumeric characters for viewing when the fixture is standing upright (i.e., resting on its bottom panel on the floor):

-  1. Press and hold <Menu> until *AddR* appears on the LED display.
-  2. Scroll to the *SET* menu. Press <Enter> to select.
-  3. Scroll to the *D/IN* menu. Press <Enter> to select.
- 
or
 4. Scroll to *ON* to invert the fixture's alphanumeric characters, or *OFF* to return the fixture's alphanumeric characters to normal orientation.
5. Press <Enter> to store.

Setting the Lamp Warning Message (LMPL)

This menu option is available in Studio Command 1200 and 700 models only. Use this menu item to enable your fixture to display the warning message LAMP LIFE ERR when the current lamp hours exceed 700. With this option enabled, after the current lamp hours exceed 800 hours, the fixture will display the warning message LAMP OUT ERR. Once the lamp is extinguished, the fixture will no longer strike the lamp until the current lamp is replaced and the current lamp hours are reset to zero (see *Replacing the Lamp* on page 58 and *Resetting Lamp Hours (L/RS)* (*Studio Command 1200/700 models only*) on page 40).

To enable the lamp warning message:

1. Press and hold <Menu> until *AddR* appears on the LED display.
2. Scroll to the *SET* menu. Press <Enter> to select.
3. Scroll to the *LMPL* menu. Press <Enter> to select.
4. Scroll to *ON* to enable the lamp warning message, or *OFF* to disable the lamp warning message.
5. Press <Enter> to store.

Data Loss Shutter Close (DLOS)

Use this menu item to determine how the fixture will react in the event of DMX data loss by closing the shutter upon Data Loss or keeping the shutter open until shut down. In the Studio Command 1200/700 model, the fixture responds to a Data Loss by closing the shutter. In Studio Command H models, the fixture responds to a Data Loss by dousing the lamp.

To select a shutter reaction to data loss:

1. Press and hold <Menu> until *AddR* appears on the LED display.
2. Scroll to the *SET* menu. Press <Enter> to select.
3. Scroll to the *dLOS* menu. Press <Enter> to select.
4. Scroll to *LONG* to close the shutter (or douse the lamp in H model) only when the fixture is shut down, or *SHRT* to close the shutter one second after data loss.
5. Press <Enter> to store.

Mode Menu (MODE)

The Mode menu sets user type, copies settings and presets between user modes, and crossloads software versions from one fixture to all other Studio Command fixtures on the link. The procedures below are listed in the same order shown on the menu map (see *Appendix D: Menu Map*).





Setting the User Type (USER)

Use this menu item to change the fixture's user type between user A and user B. Each user type includes 16 different presets (scenes) and the following fixture settings:

Start Channel Number	Pan/Tilt Swap Status	Lamp Life Warning Status
Pan Invert Status	LED Display Status	Shutter Close with DMX Data Loss Status
Tilt invert Status	LED Display Invert Status	Preset Playback Status







Each user type can be configured with its own set of scene parameters and default fixture settings. These can be utilized, for example, when a fixture is moved between two locations.

To change the user type:

-  1. Press and hold <Menu> until *AddR* appears on the LED display.
-  2. Scroll to the *MODE* menu. Press <Enter> to select.
-  3. Scroll to the *USER* menu (this will be the first option displayed). Press <Enter>.
-  4. Scroll to *A* to select User A settings, or *B* to select User B settings.
- or
-  5. Press <Enter> to store selections.

Copying User Presets (PRST)







Use this menu item to copy the fixture's preset scenes from one user mode to the other. Each user type includes 16 different presets which can be copied to the other user type. This options copies all 16 presets at one time. To copy just one preset, see *Copying an On-Board Memory Scene (COPY)* on page 24. To copy user presets:

-  1. Press and hold <Menu> until *AddR* appears on the LED display.
-  2. Scroll to the *MODE* menu. Press <Enter> to select.
-  3. Scroll to the *USER* menu (this will be the first option displayed). Press <Enter>.
-  4. Scroll to the *COPY* menu. Press <Enter> to select.
-  5. Scroll to the *PRST* menu (this will be the first menu displayed). Press <Enter>.
-  6. Scroll to *A->B* to copy User A presets to User B, or *B->A* to copy User B presets to User A.
- or
-  7. Press <Enter> to store selection.

Copying User Settings (SETT)

Use this menu item to copy the fixture's user settings from one user mode to the other. The user settings for each user type are listed in the section titled *Setting the User Type (USER)* on page 30. This options copies all user settings at one time.

To copy user settings:







-  1. Press and hold <Menu> until *AddR* appears on the LED display.
-  2. Scroll to the *MODE* menu. Press <Enter> to select.
-  3. Scroll to the *USER* menu (this will be the first option displayed). Press <Enter>.
-  4. Scroll to the *COPY* menu. Press <Enter> to select.
-  5. Scroll to the *SETT* menu. Press <Enter> to select.
-  6. Scroll to *A→B* to copy User A settings to User B, or *B→A* to copy User B settings to User A.
or
-  7. Press <Enter>.

Copying User Presets and Settings (ALL)

Use this menu item to copy the fixture's 16 user preset scenes and fixture settings from User A to User B or vice versa. The user settings for each user type are listed in the section titled *Setting the User Type (USER)* on page 30.

Note: *This options copies all user settings and all 16 presets at one time.*

To copy user presets and settings:

-  1. Press and hold <Menu> until *AddR* appears on the LED display.
-  2. Scroll to the *MODE* menu. Press <Enter> to select.
-  3. Scroll to the *USER* menu (this will be the first option displayed). Press <Enter>.
-  4. Scroll to the *COPY* menu. Press <Enter> to select.
-  5. Scroll to the *ALL* menu. Press <Enter> to select.
-  6. Scroll to *A→B* to copy User A presets and settings to User B, or *B→A* to copy all User B presets and settings to User A.
or
-  7. Press <Enter> to store selection.

Crossloading Fixture Software (XLD)

If you have a Studio Command fixture with a newer software version, you can crossload the newer software to all other Studio Command fixtures on the link.

Before crossloading, disconnect any consoles, bypass any serial data distributors and/or data line optoisolators, and bypass or make sure that any fixtures using RS-422 communications (such as Dataflash® AF1000 xenon strobes and Intellabeam® fixtures) are located after the Studio Command fixtures on the link. These devices will block communication with any other Studio Command fixtures on the link.

To crossload software to all other Studio Command fixtures on the link:



1. Press and hold <Menu> until *AddR* appears on the LED display.



2. Scroll to the *MOdE* menu. Press <Enter> to select.



3. Scroll to the *XLd* option.

4. Press <Enter>. The fixture will upload its software to all other Studio Command fixtures on the link.

The Transmit LED on the crossloading fixture will remain on (or flicker) and the Transmit and Receive LEDs on receiving fixtures will flicker while the crossload is in progress.

The alphanumeric LED on the Studio Command fixtures will display *UPLD* as they are receiving the software upload. When the crossload has finished successfully, *DONE* will appear briefly in the LED display of the crossloading fixture, and all other fixtures will home.



Note: *If a new boot code was included with the newer software, the alphanumeric LED will display a BOOT DIFF error. To correct the boot code, you must copy the new boot code for each fixture (see Copying the Boot Code (BOOT) on page 33).*

Test Menu (TEST)

The Test menu allows you to manually home the fixture, turn the lamp on or off, store new boot code information, and perform fixture self tests to determine the origin of mechanical problems.





Homing the Fixture (HOME)

This menu item allows you to manually home the fixture. To remotely home the fixture using a DMX console, see *Control Parameter* on page 53. To manually home the fixture:

-  1. Press and hold <Menu> until *AddR* appears on the LED display.
-  2. Scroll to the *TEST* menu. Press <Enter> to select.
-  3. Scroll to the *HOME* option (this will be the first option displayed).
4. Press <Enter>. The LED will alternately display *RST* and *HOME* while the fixture homes.



Turning the Lamp On or Off (LAMP)

This menu item allows you to manually strike or extinguish the lamp. To remotely strike or extinguish the lamp using a DMX console, see *Control Parameter* on page 53. To manually turn the lamp on or off:

-  1. Press and hold <Menu> until *AddR* appears on the LED display.
-  2. Scroll to the *TEST* menu. Press <Enter> to select.
-  3. Scroll to the *LAMP* menu. Press <Enter> to select.
-  4. Scroll to *ON* to strike the lamp, or *OFF* to extinguish the lamp.
- or*
-  5. Press <Enter>.

Copying the Boot Code (BOOT)

New software uploaded to Studio Command fixtures may contain a new boot code which must be copied to each BOOT section of the FlashROM. In this case, the LED displays a BOOT DIFF error. To accept and store the new boot code:

-  1. Press and hold <Menu> until *AddR* appears on the LED display.
-  2. Scroll to the *TEST* menu. Press <Enter> to select.
-  3. Scroll to the *BOOT* option.
4. Press <Enter> to start the reboot. The fixture stores the new boot code, then automatically homes.

Note: *Do not remove power from the fixture while performing a boot copy.*

Performing Self Tests (SELF)

The following self tests are available:

Construct	Self-Test Description
ALL	performs all of the self tests listed below
PAN	moves the pan motor from 0° to 540°
TILT	moves the tilt motor from 0° to 240°
CYAN	divides the cyan color wheel into eight equal sections (positions) and rotates the cyan color wheel from position 1 through 8
MAGN	divides the magenta color wheel into eight equal sections (positions) and rotates the magenta color wheel from position 1 through 8
YELW	divides the yellow color wheel into eight equal sections (positions) and rotates the yellow color wheel from position 1 through 8
SHUT	performs strobe functions
DIM	moves the dim wheel from closed to fully open

To see the effects of the self tests, the lamp must be on. If the lamp is off when you run the self test, the LED will display LAMP to indicate that the lamp is not struck, and the fixture will attempt to strike the lamp automatically. Self tests run continuously until you press <Menu> to exit the test. To perform a self test:

AddR

1. Press and hold <Menu> until *AddR* appears on the LED display.

TEST

2. Scroll to the *TEST* menu. Press <Enter> to select.

SELF

3. Scroll to the *SELF* menu. Press <Enter> to select.

4. Scroll to the desired option (listed above).

5. Press <Enter> to start the test. The fixture will perform the selected self test.

6. Press <Menu> to exit the test.

Placing the Fixture in Setup Mode (S/UP)

This menu item is used as part of the service procedure for replacing motor. To place the fixture in setup mode:

AddR

1. Press and hold <Menu> until *AddR* appears on the LED display.

TEST

2. Scroll to the *TEST* menu. Press <Enter> to select

S/UP



3. Scroll to the *S/UP* option.

4. Press <Enter>. When the LED displays *SET NOW*, the fixture mechanically homes the dim flags.

5. After mechanically homing press any button to reset and home the fixture.

Testing the LED Display (DISP)





To test the alphanumeric LED display:

-  1. Press and hold <Menu> until *AddR* appears on the LED display.
-  2. Scroll to the *TEST* menu. Press <Enter> to select.
-  3. Scroll to the *DISP* option. Press <Enter> to select. The alphanumeric display runs through its self test.
4. Press <Menu> to exit the test.

Changing Encoder Operation (ENCD)

This menu option to disable the encoders which work to automatically correct the fixture's pan and tilt position if the fixture is moved from its programmed position. Use this option when performing maintenance, to prevent the fixture from repeatedly trying to correct its position.

To enable/disable the encoders:

-  1. Press and hold <Menu> until *AddR* appears on the LED display.
 -  2. Scroll to the *TEST* menu. Press <Enter> to select.
 -  3. Scroll to the *ENCD* option. Press <Enter> to select.
 -  4. Scroll to *ON* to enable the encoders, or *OFF* to disable the encoders.
- or*
-  5. Press <Enter> to store.

Information Menu (INFO)

The Information menu allows you to view current fixture information such as internal temperature, lamp hours, fixture hours, lamp strikes, software version, DMX errors, and DMX data for any other device on the link. You can also reset the lamp hours, lamp strikes and fixture hours. The procedures below are listed in the same order shown on the menu map (see *Appendix D: Menu Map*).

Viewing Sensor Information (SENS)

This menu option allows you to view whether a specified sensor is working correctly or to view encoder position values. If you receive a *SENS ERR* error message on the alphanumeric display, this information may help you determine where the problem originates

Sensor/encoder information is available for the following:

Parameter	Description
TILT	tilt sensor
PAN	pan sensor
TPOS	tilt encoder
PPOS	pan encoder

To view sensor and encoder information:



1. Press and hold <Menu> until *Addr* appears on the LED display.



2. Scroll to the *INFO* menu. Press <Enter> to select.



3. Scroll to the *SENS* menu. Press <Enter> to select.

4. Scroll to the desired sensor or encoder (listed above).

5. Press <Enter> to store the selection. If you are viewing a sensor, the LED will display *ON* or *OFF* indicating the status. If you are viewing an encoder, the LED will display the current numeric position of the encoder.

Viewing Fixture DMX Status and Parameter Values (FIXT)

This menu option allows you to view DMX status and parameter values for the fixture. You may want to view the DMX status and parameter values for a fixture if you are having a particular problem with a fixture; for example, a color wheel that does not respond to commands from the console.

The following DMX status information is available for viewing:

Construct	DMX Status
BRKS	framing errors with value of zero (i.e. DMX breaks)
FE	framing errors with a non-zero value (i.e. errors in data transmission)
OV	overruns (changing values could indicate data link/connector problems)
STRT	start code

The following parameter values are available for viewing according to the selected protocol.

DMX Values Available for Viewing	
Construct	Value
PANH	high 16-bit pan value
PANL	low 8-bit pan value
TLTH	high 16-bit tilt value
TLTL	low 8-bit tilt value
COLC	color control value
CYAN	cyan color wheel position
MAGN	magenta color wheel position
YELW	yellow color wheel position
ZOOM	beam angle position
SHUT	shutter strobe value
DIM	shutter dim flag value (Not available in Studio Command H models)
MSPD	MSpeed time value
MACR	macro value
CNTL	control channel value

To view the DMX status and parameter values:

1. Press and hold **<Menu>** until *AddR* appears on the LED display.
2. Scroll to the *INFO* menu. Press **<Enter>** to select.
3. Scroll to the *dMX* menu. Press **<Enter>** to select.
4. Scroll to the *FIXT* menu (this will be the first option displayed). Press **<Enter>**.
5. Scroll to the desired DMX status or parameter value.
6. Press **<Enter>**. The LED will display the selected DMX status or parameter value.

If you have a particular problem with the fixture, follow the steps above to select a parameter and view its value. After noting the value of the parameter you selected, use your DMX console to change that parameter's value.

If the value changes on the fixture's LED display, but the fixture still does not respond, contact High End Systems customer service in one of the ways shown in the section titled *Contacting High End Systems®* on page ii.

If the value does *not* change on the fixture's LED display, remove the fixture from the DMX link and try to change the parameter's value using the fixture's menu system. If the fixture then functions normally, the problem was likely with the DMX link. Otherwise, contact High End Systems customer service (see *Contacting High End Systems®* on page ii).

Viewing DMX Data for Another Device (DATA)







This procedure allows you to use a Studio Command fixture to view DMX channel values for other devices on the DMX link. Use this menu option for testing devices that do not have built-in DMX diagnostics, or fixtures that are physically inconvenient to monitor directly.

If you experience a problem with a device on the link, use this menu to select a DMX channel in the device's channel range and view its DMX value. After noting the value of the channel you selected, use your DMX console to change that channel's value.

If the value of the DMX channel you selected does not change, there may be a problem with the DMX cable or your transmitting device (i.e. DMX console).

If the DMX channel value changes, but the device does not respond, the device may be faulty. Consult the documentation provided with that device for more information.





To view DMX data for another device on the DMX link:

-  1. Press and hold <Menu> until *AddR* appears on the LED display.
-  2. Scroll to the *INFO* menu. Press <Enter> to select.
-  3. Scroll to the *dMX* menu. Press <Enter> to select.
-  4. Scroll to the *dATA* menu. Press <Enter>.
-  5. Scroll to the desired DMX channel (C001–C512).
-  6. Press <Enter>. The LED will display the selected channel's DMX value.

Viewing the Current Logic Board Temperature (PCB)

This menu option allows you to view the current ambient temperature at the logic board inside the fixture.





To view the logic board temperature:

-  1. Press and hold <Menu> until *Addr* appears on the LED display.
-  2. Scroll to the *INFO* menu. Press <Enter> to select.
-  3. Scroll to the *TEMP* menu. Press <Enter> to select.
-  4. Scroll to the *PCb* option.
5. Press <Enter>. The LED will display the current internal temperature of the fixture's logic board in degrees centigrade.
6. The maximum temperature for the logic board is 85 C. When maximum temperature is exceeded, the fixture shuts down and the display shows *PCB TEMP ERR*. For more information, see *Alphanumeric Display Error Messages* on page 63.

Viewing the Current Fixture Head Temperature (HEAD)

This menu option lets you view the current ambient temperature inside the fixture head.

To view the fixture's head temperature:

-  1. Press and hold <Menu> until *Addr* appears on the LED display.
-  2. Scroll to the *INFO* menu. Press <Enter> to select.
-  3. Scroll to the *TEMP* menu. Press <Enter> to select.
-  4. Scroll to the *HEAD* option.
5. Press <Enter>. The LED will display the current internal temperature of the fixture's head in degrees centigrade.

Note: *The maximum temperature for the fixture head is 100 C. If this maximum temperature is exceeded, the fixture will shut down and the alphanumeric display will show HEAD TEMP ERR. For more information, see Alphanumeric Display Error Messages on page 63.*

Resetting Fixture Hours (F/RS)

Use this menu to reset the recorded number of hours the fixture has been on.

To reset the fixture hours to zero:

1. Press and hold <Menu> until *AddR* appears on the LED display.

2. Scroll to the *INFO* menu. Press <Enter> to select.

3. Scroll to the *F/RS* option.

4. Press <Enter> to store the selection. The LED will display *0000* when the fixture hours are reset.

Note: *This option has a five-second delay to avoid inadvertent changes. To reset the fixture hours, you must press and hold the <Enter> button for at least five seconds.*

Viewing the Current Fixture Hours (F/HR)

To view the number of hours the fixture has been on since this option was reset:

1. Press and hold <Menu> until *AddR* appears on the LED display.

2. Scroll to the *INFO* menu. Press <Enter> to select.

3. Scroll to the *F/HR* option.

4. Press <Enter>. The LED will display the number of hours the fixture has been on.

Resetting Lamp Hours (L/RS) (Studio Command I200/700 models only)

This option (functional for Studio Command 1200/700 fixtures only) resets the hours the current lamp has been operating to zero. You should reset the lamp hours each time you replace the lamp (see *Replacing the Lamp* on page 58).

To reset the current lamp hours to zero:

1. Press and hold <Menu> until *AddR* appears on the LED display.

2. Scroll to the *INFO* menu. Press <Enter> to select.



3. Scroll to the *L/RS* option.

4. Press <Enter>. The LED will display *0000* when the lamp hours are reset.

Note: *This option has a five-second delay to avoid inadvertent changes. To reset the lamp hours, you must press and hold the <Enter> button for at least five seconds.*

Viewing the Number of Current Lamp Strikes (L/ST)



This option is functional for Studio Command 1200/700 fixtures only. To view the number of times the fixture has attempted to strike the current lamp:

-  1. Press and hold <Menu> until *AddR* appears on the LED display.
-  2. Scroll to the *INFO* menu. Press <Enter> to select.
-  3. Scroll to the *L/ST* option.
4. Press <Enter>. The LED will display the number of times the fixture has struck the current lamp.

Note: *Lamp strikes are automatically reset when the lamp hours are reset (see Resetting Lamp Hours (L/RS) (Studio Command 1200/700 models only) on page 40).*



Viewing the Current Lamp Hours (L/HR)

This option is functional for Studio Command 1200/700 fixtures only. To view the number of hours the current lamp has been on:

-  1. Press and hold <Menu> until *AddR* appears on the LED display.
-  2. Scroll to the *INFO* menu. Press <Enter> to select.
-  3. Scroll to the *L/HR* option.
4. Press <Enter>. The LED will display the number of hours the current lamp has been on.

Viewing the Current Software Version (VER)

To view the current software version:

-  1. Press and hold <Menu> until *AddR* appears on the LED display.
-  2. Scroll to the *INFO* menu. Press <Enter> to select.
-  3. Scroll to the *VER* option.
4. Press <Enter>. The LED will display the fixture's current software version.

Note: *The software version is also displayed when you exit the menu system (see Alphanumeric Display Error Messages on page 63).*

Scene Creation, Looping and Playback Example

Step-by-Step Scene Creation

Use the following example to create a sample scene using the fixture's menu system to choose a value for each of the available parameters. For more information on available parameters, see *Appendix D: Menu Map*.

Note: *This example assumes a Studio Command 1200/700 model. The DIM option will not be functional in Studio Command H fixtures.*

Choose a Scene to Create/Edit:

1. Press and hold <Menu> until *AddR* appears on the LED display.

2. Scroll to the *PRST* menu. Press <Enter> to select.

3. Scroll to the *EdIT* menu. Press <Enter> to select.

4. Scroll to the scene you want to create (in this example, *SN01*).

5. Press <Enter> to store the selection.

Select a Shutter Value (SHUT):

1. Scroll to the *SHUT* parameter (this will be the first parameter displayed). Press <Enter> to select.

2. Scroll to the desired shutter value (in this example, *OPEN*).

3. Press <Enter> to store the selection.

Select a Dim Value (DIM):

1. Scroll to the *dIM* parameter. Press <Enter> to select.

2. Scroll to the desired dim value (in this example, *d255*).

3. Press <Enter> to store the selection.



Select a Pan Value (PAN):

1. Scroll to the *PAN* parameter. Press <Enter> to select.



2. Scroll to a pan value from -49.9 to +49.9 (in this example, *+30.5*).

3. Press <Enter> to store the selection.



Select a Tilt Value (TILT)

-  1. Scroll to the *TILT* parameter. Press <Enter> to select.
-  2. Scroll to the desired tilt value from -49.9–+49.9 (in this example, -20.3).
3. Press <Enter> to store the selection.



Choose a Color Wheel Control Value (COLC)

-  1. Scroll to the *COLC* parameter. Press <Enter> to select.
-  2. Scroll to the desired color wheel control value (in this example, Continuous).
3. Press <Enter> to store the selection.



Select a Cyan Wheel Position (CYAN)

-  1. Scroll to the *CYAN* parameter. Press <Enter> to select.
-  2. Scroll to the desired cyan color saturation level (in this example, a DMX value of 203).
3. Press <Enter> to store the selection.



Select a Magenta Wheel Position (MAGN)

-  1. Scroll to the *MAGN* parameter. Press <Enter> to select.
-  2. Scroll to the desired magenta color saturation level (in this example, a DMX value of 60).
3. Press <Enter> to store the selection.



Select a Yellow Wheel Position (YELW)

-  1. Scroll to the *YELW* parameter. Press <Enter> to select.
-  2. Scroll to the desired yellow color saturation level (in this example, a DMX value of 255 or full saturation).
3. Press <Enter> to store the selection.

Select the Zoom Function (ZOOM)



-  1. Scroll to the *ZOOM* parameter. Press <Enter> to select.
-  2. Scroll to the desired value (in this example, a DMX value of 255).
3. Press <Enter> to store the selection.

Set an MSpeed Value (MSPD)



-  1. Scroll to the *MSPD* parameter. Press <Enter> to select.
-  2. Scroll to the desired MSpeed (in this example, 1.5) in decimal seconds.
3. Press <Enter> to store the selection.

Note: *In this example, the MSpeed value only affects the pan and tilt parameters, because the pan and tilt values default to MSpeed time, and no other parameters with MSpeed values were chosen.*

Choose a Macro (MACR)



-  1. Scroll to the *MACR* parameter. Press <Enter> to select.
-  2. Scroll to the desired macro value (in this example, *MCOF*).
3. Press <Enter> to store the selection.

Set a Crossfade Value (XFAD)

-  1. Scroll to the *xFAd* parameter. Press <Enter> to select.
-  2. Scroll to the desired crossfade value in increments of 0.1 or 1 (in this example, *x 1.5*).
3. Press <Enter> to store the selection.

Note: *The crossfade value will affect the DIM and ZOOM parameters. Set the unit of time used for crossfade (seconds, minutes, or hours) using the TIME parameter. Cyan, Magenta and Yellow are crossfaded in continuous and pure mix modes that do not use MSpeed.*

Set a Delay Value (DLAY)

-  1. Scroll to the *dLAY* parameter. Press <Enter> to select.
-  2. Scroll to the desired delay value in increments of 0.1 or 1 (in this example, *d 6.0*).
3. Press <Enter> to store the selection.

Note: *The delay value determines the length of the scene. If you want all motor transitions to be completed before the next scene begins, XFAD or MSPD must be less than or equal to DLAY. If XFAD or MSPD is longer than DLAY, the motor movement will not be completed before the next scene begins, which could produce undesirable results - such as no light output during the scene.*

Set the unit of time used for delay (seconds, minutes, or hours) using the TIME parameter.

Set the Time Unit (TIME)

1. Scroll to the *TIME* parameter. Press <Enter> to select.
2. Scroll to the desired time value (in this example, *SEC*).
3. Press <Enter> to store the selection.

Note: *This parameter sets the unit of time used in for the XFAD and DLAY values.*

Erase the Scene (ZERO)

1. Scroll to the *ZERO* parameter.
2. Press <Enter> to select. The LED will display *OK?*
3. In this example, press the <Menu> button. Pressing the <Menu> button will exit this parameter and leave the current scene as programmed. Pressing the <Enter> button will erase the current scene and mark the end of a loop.

Creating a Loop

A loop is a series of programmed scenes that continuously plays in sequential order. To create a loop, you must first create two or more contiguous scenes (see *Step-by-Step Scene Creation* on page 42). After you have created your scenes, go to the *next available* scene and choose the ZERO menu option to erase any programmed parameter values and mark the end of the loop.

Note: *If you program all available on-board scenes, you do not have to mark the end of the loop. When preset playback is set on, the fixture will automatically loop after playback of all programmed scenes.*

Playing Back a Loop

To play back a loop, you must set preset playback on for each fixture (see *Setting Preset Playback (PLAY)* on page 23). When preset playback is set on, your fixture will automatically begin playing back the first scene and continue through the loop.

Note: *Scene 1 must be programmed to enable preset playback.*

The fixture has two ways to indicate that preset playback is on. First, the display will show a dot in the lower right corner. Second, during normal operation, the seven-segment LED cycled information will be changed to display PRST instead of the fixture's software version (Vxxx).

If power is removed during playback, the fixture will home and begin playback at the first scene. To stop playback, manually set playback mode off, (see *Setting Preset Playback (PLAY)* on page 23).

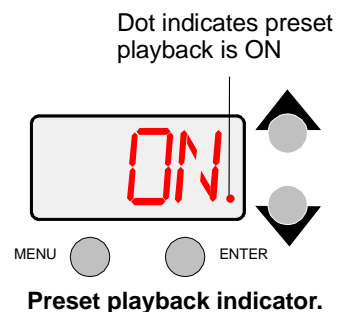

Synchronizing Preset Playback

After creating one or more scenes for your fixtures, you can synchronize the preset playback for all Studio Command™, Studio Command®, x.Spot®, Studio Spot™ 250, Studio Color® 250, Studio Color® 575, Studio Spot™ 575, EC-1™, ES-1™, Technobeam®, Color Pro® HX, HXi, or FX fixtures in the link.

Note: *Synchronizing preset playback is applicable for fixtures operating in stand-alone mode only. Do not include a DMX console in the link while synchronizing preset scene playback.*

Synchronizing playback allows you to set all applicable fixtures to a master clock so that all fixtures have a definite, synchronized starting point when playing back their sequences (or loops). It is the master fixture (the fixture assigned DMX start channel 1) which determines the sequence length for *all* the other fixtures in the link (slave fixtures), regardless of the number of programmed scenes or the sequence length of the individual slave fixtures.

When the master fixture reaches the end of its last scene, *all* fixtures will restart at scene 1 (regardless of whether the slave fixtures have finished playing their scenes) and *all* the clocks will be reset to zero.

For example, if a slave fixture has a shorter sequence length, it will continuously repeat its sequence until the master fixture resets all the clocks. If a slave fixture has a longer sequence length, it will restart at scene 1 before it completes its entire sequence.

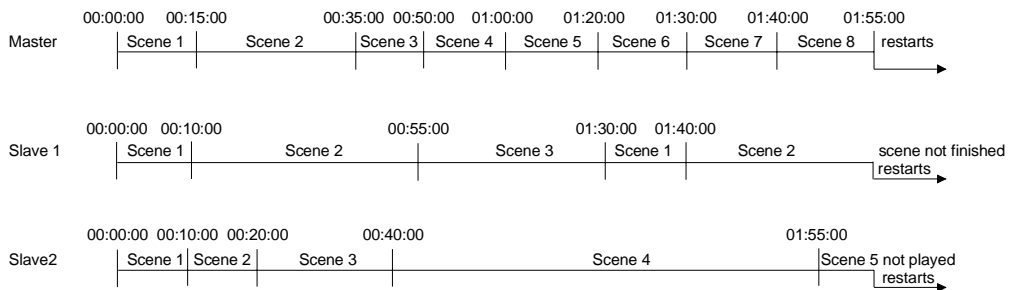

Example of synchronized playback.

To enable synchronized playback:

1. Link the fixtures you want to synchronize (see *Standalone Fixture Linking* on page 16). Make sure you terminate *both* the first and the last fixtures in the link and that there are no DMX consoles on the link.
2. Assign one fixture as the master fixture by assigning it a unique DMX start channel 1 or fixture number 1 (see *Assigning a DMX Start Channel* on page 18). Make sure *no other fixture* on the link is assigned DMX start channel 1 or fixture number 1.
3. Set preset playback on for all fixtures on the link (see *Setting Preset Playback (PLAY)* on page 23).

Chapter 4:

Fixture Programming

Programming control features for Studio Command™ fixtures include:

- Assigning a DMX start channel
- Accessing and setting fixture options
- Viewing fixture status
- Crossloading software
- Performing self tests
- DMX Programming for creating, storing, and playing scenes

The Onboard Menu System controls all these features via the LED display. A DMX console can provide remote DMX programming to all fixtures on a link and, if it is running TalkBack protocol, remote control of other fixture operations listed above.

For more information on the Studio Command Menu System, see *Chapter 3: The Menu System* and *Appendix D: Menu Map*.

TalkBack™ Support for Remote Access

All Studio Command fixtures support TalkBack™ technology. TalkBack™ technology allows remote access to the menu system built into High End Systems fixtures. A DMX console supporting TalkBack can remotely access any option in the Studio Command onboard menu system.

TalkBack protocol uses the normal DMX-512 connection for bi-directional communication with the fixture so physical access to the fixture is no longer required to perform operations like changing a DMX address or configuring preset programs. TalkBack protocol utilizes the primary DMX link (pins 2-3) in a half-duplex communication mode. This means that it does not require pins 4-5 to be connected or used to receive TalkBack messages coming from the fixture.

TalkBack protocol uses a discovery process to find the unique number that is embedded inside each fixture, similar to a serial number. Once the fixtures have all been identified, the current fixture parameter settings and information can be accessed. Fixture access can happen at anytime, but the Talkback messages are only valid after the fixture starts homing.

DMX Programming Overview

A Parameter (parameter) is a fixture attribute that can be controlled to modify the light beam in terms of color, beam quality and pattern, intensity, or focus (position). DMX programming assigns a DMX value to each of the fixture's parameters. A scene (sometimes referred to a *look* or a *cue*) is one combination of parameter settings. These scenes are the building blocks for show creation.

Full Speed versus MSpeed Control

Some parameters can be set to operate at full speed or MSpeed (motor speed). Full speed operations are completed in the shortest length of time after the motor starts moving. With MSpeed control, change occurs smoothly over the entire MSpeed time value selected. For example, if you select an MSpeed time of 30 seconds, the motor will gradually change position until it reaches its new destination at the end of 30 seconds.

DMX Programming Options

Studio Command fixtures can be programmed to create and play back scenes with either a DMX-compatible controller or with Onboard Menu System Preset programming (for stand-alone operation). However, you cannot use both a DMX compatible controller and the fixture's on-board menu system at the same time. In other words, you cannot create a scene using the on-board memory and play it back using a controller. You also cannot use a controller at the same time on-board scenes are playing.

Using a DMX controller, you can program an unlimited number of sequences (combinations of scenes) and retain direct control over the Studio Command fixture at all times. You may choose to save time by programming your fixtures using a controller and then capturing the scene(s) to the on-board memory of multiple Studio Command fixtures.

If you plan to operate your fixtures without a DMX controller, you can utilize one of the fixtures on the link to synchronize preset playback among all fixtures of that type connected to the DMX link.

Note: *Because controllers cannot transmit crossfade or delay parameter values, you must use preset programming in the onboard menu system to manually set those parameter values at the fixture.*

Programming with a DMX Console

The Wholehog III[®] Lighting Console, and the Hog iPC console are available from High End Systems to control Studio Command fixtures (see *Related Products and Accessories* on page 4). For more information on whether your DMX controller supports Studio Command fixtures, contact the controller's vendor. For more information on operating your fixture with a controller (or control device such as DMX control software), consult the documentation provided with the controller.

DMX Programming Using the Onboard Menu System

Fixture level DMX programming is executed in the Preset portion of fixture's Onboard Menu system, see *Preset Menu (PRST)* on page 23. For more detailed information on all the settings you can control in Studio Command fixtures using the onboard Menu System, see *Chapter 3: The Menu System* and *Appendix D: Menu Map*.

Parameter Function Descriptions

The following sections describe the Parameters for Studio Command fixtures running Standard or Flat DMX Protocol. All DMX values indicated in the detailed parameter descriptions are in decimal units. See *Appendix A: Studio Command™ DMX Protocol* for complete DMX tables.

Pan and Tilt Parameters

The **Pan** and **Tilt** parameters control the Studio Command fixture's 540° pan range and 240° tilt range. Pan and Tilt functions each utilize two channels to provide 16 bit adjustment to a fraction of a degree.

Pan and Tilt motion for Studio Command fixtures is controlled with MSpeed values by default, (see *MSpeed (Motor Speed) Parameter* on page 52). If you choose to control the Pan and Tilt parameters with DMX controller crossfading, set Pan/Tilt MSpeed off in the Control parameter (see the DMX tables in *Appendix A: Studio Command™ DMX Protocol*).

Note: *Optical encoders for pan and tilt correct the fixture's position if the fixture is jarred from its programmed position. If a physical obstruction prevents the fixture from correcting its position, the fixture "times out" to prevent wear on the motors. If your fixture has timed out, remove the obstruction and home the fixture to return it to normal operation.*

Color Function Parameter

The **Color Function** parameter determines color selection options. The Color Function mode can be enabled in either full speed (controller crossfading the wheel positions), or MSpeed (MSpeed control of the wheel motor). For more information on MSpeed, see *MSpeed (Motor Speed) Parameter* on page 52.

The Color Function you choose will effect which parameter values are available for each individual color (Cyan, Magenta, and Yellow). The following table describes the Color Functions available on the Studio Command fixture.

Color Function	Description
Continuous	Allows exact positioning at any point on the color wheel for a smaller <i>step</i> between color wheel positions for color crossfades.
Random	Selects whole color positions at variable speeds. Random speed is set by the Cyan channel.
Cycle	Cycles through colors. Cycle speed is set by the Cyan channel.

Cyan, Magenta, and Yellow Parameters

Cyan, Magenta and **Yellow** parameters determine color mixing options. The color options available are determined by the Color Function parameter DMX value you choose.

Zoom Parameter

The **Zoom** parameter is controls the Zoom range from 18° at a DMX value of 0 to 33° at a DMX value of 255.

Shutter Function Parameter

Studio Command I200/700 Models

Basic **Shutter** functions can be selected when no lamp or dimming functions are set in the **Control** channel.

Shutter Function	Description
Close	Closes shutter
Periodic Strobe	Strobes beam at specified intervals. Periodic strobes transition smoothly from mechanical strobes to electronic strobes. Mechanical strobes support 1-4 Hz operation. Electronic strobes support 5-33Hz operation.
Random Strobe	Allows all Studio Command Fixtures on the DMX link to strobe their shutters at random times.
Random/Synchronous Strobe	Allows all Studio Command Fixtures on the DMX link to strobe their shutters at random times in unison.
Ramp Open/Snap Shut	Opens shutter at variable speeds, then snaps shut at full speed
Snap Open/Ramp Shut	Opens shutter at full speed, then ramps shut
Ramp Open/Ramp Shut	Opens shutter at variable speeds, then ramps shut
Random Ramp Open/Snap Shut	Opens shutter at random variable speeds, then snaps shut at full speed
Random Snap Open/ Ramp Shut	Opens shutter at full speed, then ramps shut at random variable speeds
Open	Opens shutter

The Control channel also qualifies the Shutter parameter to create lamp boost, lightning and strobing effects.

Control Channel Setting	Shutter Function	Description
Values 134-137 Lamp Assisted Strobes	Close	Shutter functions are the same as normal Shutter functions. Periodic and random random and random synchronous strobe functions are lamp assisted. Ramping functions are not lamp assisted.
	Periodic Strobe	
	Random/Random Strobe	
	Random/Synchronous Strobe	
	Ramp Open/Snap Shut	
	Snap Open/Ramp Shut	
	Ramp Open/Ramp Shut	
	Random Ramp/Snap	
	Random Snap/Ramp	
	Open	
Values 138-141 Lamp Functions	Close	The Boost effect boosts the Lamp above the fixture's Watt level for the specified period of time. The lamp is also boosted during the Lightning effects.
	Periodic lamp strobes	
	Random/random lamp strobes	Before another Boost or Lightning effect can occur, the Shutter channel must be moved to either closed or open, or the Lamp Control channel must be moved outside the Lamp Function range.
	Synchronous/random lamp strobes	
	Boost lamp, black. Six time ranges from 1–.25 second	Boost effects to black boost the lamp for a specified time then close the shutter.
	Boost lamp, white. Six time ranges from 1–.25 second	Boost effects to white boost the lamp for a specified time, then leave the shutter open with the lamp dimmed.
	Lightning strike	When a Lightning effect is selected, the Dim channel scales the overall brightness of the lightning stroke.
	Open	
Values 146-149 Lamp Dimming	Closed	Shutter functions are same as normal shutter function range. Dimming is accomplished electronically, lowering the lamp power. Dimming will not go to black. Strobes are mechanical and will go to black.
	Open	

Studio Command H Model

Basic **Shutter** functions.

Shutter Function	Description
Open	Shutter open, Activates control channel when DMX value = 0 – 23
Periodic Strobe	Strobes beam at specified intervals
Random Strobe	Allows all Studio Command Fixtures on the DMX link to strobe their shutters at random times.
Random/Synchronous Strobe	Allows all Studio Command Fixtures on the DMX link to strobe their shutters at random times in unison.
Open	Opens shutter

Dim Parameter

In Studio Command 1200/700 fixtures, the Dim parameter provides full dimming capability without changing the color temperature or the beam shape. The dim values range from closed (DMX value of 0) to fully open (DMX value of 255).

MSpeed (Motor Speed) Parameter

The **MSpeed** parameter controls the time required for a motor to complete movement when changing from one position to another. MSpeed provides a means for all motors to reach their target position at the same time, even though each motor may have different distances to travel. MSpeed movement is extremely smooth because the fixture controls its own movements and is not dependent on DMX refresh rates.

MSpeed times vary from 0.15 seconds to 252.7 seconds. However, if you apply MSpeed to a parameter, be sure that the delay value (length of time allowed for the entire scene) is longer than the MSpeed value to allow the motors to complete their movement before the end of the cue. An MSpeed value that is longer than the delay value could produce an undesirable result; for example, no light output during the scene. For a listing of exact MSpeed times, see *Appendix B: MSpeed Conversion Table*.

By default, MSpeed is applied to Pan and Tilt positioning. However, you can disable MSpeed for pan and tilt with the Control parameter. You can also apply MSpeed times to the Color Function settings, see *Color Function Parameter* on page 49.

Macro Parameter

The Macro parameter controls Internal Effects™ macros. These are factory-programmed sequences that allow you to quickly program complicated looks in one scene (cue). Each Internal Effect™ macro modifies a specific set of parameters, while allowing user control of all other parameters in the scene. The amplitude of the position macro movement is determined by the Pan Coarse channel and Tilt Coarse channel, respectively. The MSpeed channel controls the speed of the macros.

With the MSpeed set at the default value of DMX 0-4, an Internal Effects macro completes its movement in approximately 2.5 seconds. This provides a pleasing look when the additional variation given by using the MSpeed channel is not required. With the MSpeed set between DMX 5-255, Internal Effects macros complete movement at the selected MSpeed time (up to 25 seconds).

Those fixture types that support On Board Programming also support the Internal Effects macros as part of the On Board programming features. The Internal Effects macros operate as an additional programming parameter labeled MACR.

The four Internal Effect available on a standard configuration Studio Command fixture are Pan Sweep, Tilt Sweep, Clockwise Circle and Counterclockwise Circle.

Control Parameter

The Control parameter activates certain Fixture, Shutter, and Lamp functions on other Channels. To access all control settings in Standard Protocol (except for Pan & Tilt MSpeed Off), first select a control channel value, then set the Shutter channel to "0."

Studio Command I200/700

Control Setting	Description	Notes	
Safe	Disables all Control settings for normal operation. The Control channel should not be crossfaded.		
Pan & Tilt MSpeed Off	Sets Pan & Tilt MSpeed to off. The Control channel should not be crossfaded.	Command is sent instantaneously	
Display Off	Sets display to off.	Commands must be sent for 20 consecutive DMX packets (1.25 seconds).	
Display Dim	Dims display characters.		
Display Bright	Brightens the display characters.		
Home	Remotely homes the fixture.		
Lamp On	Remotely restrikes the fixture's lamp.		
Lamp Off	Remotely extinguishes the fixture's lamp.	Commands must be sent for 5 seconds.	
Shutdown	Remotely deactivates the fixture. When a fixture is shut down, the lamp is extinguished, power to the motors is disabled, and the LED display reads "SHUT DOWN". If a fixture is in shutdown mode, you must home the fixture to bring it back into operation.		
Lamp Assisted Strobes	Periodic and Random strobe functions are lamp assisted. Ramp functions are not lamp assisted.		The shutter does not have to be set to 0 for Lamp functions
Lamp functions	Modifies the shutter channel		
Lamp/mechanical dimming	Lamp output will vary from a minimum to 1200/700 Watts as the mechanical dimming ranges from 0–100%		
Lamp only dimming	Electronic dimming only from a minimum to 1200/700 Watts.		

Studio Command H

Control Setting	Description	Notes
Safe	Disables all Control settings for normal operation. The Control channel should not be crossfaded.	
Pan & Tilt MSpeed Off	Sets Pan & Tilt MSpeed to off. The Control channel should not be crossfaded.	Command is sent instantaneously
Display Off	Sets display to off.	Commands must be sent for 1.25 seconds.
Display Dim	Dims display characters.	
Display Bright	Brightens the display characters.	
Home	Remotely homes the fixture.	
Shutdown	Remotely deactivates the fixture. When a fixture is shut down, the lamp is extinguished, power to the motors is disabled, and the LED display reads "SHUT DOWN". If a fixture is in shutdown mode, you must home the fixture to bring it back into operation.	Commands must be sent for 5 seconds.

Chapter 5:

General Maintenance

This chapter includes information on replacing parts, optimizing the lamp, cleaning the fixture, and updating fixture software. Please note the warnings under each heading before servicing your fixture.



Warning: This fixture must be serviced by qualified personnel. The information listed in this chapter is intended to assist qualified personnel *only*.

Replacing Parts



Warnings: Disconnect power before servicing.

Replace fuses with the specified type and rating only.



Equipment surfaces may reach temperatures up to 160° C (320° F). Allow the fixture to cool before handling.

Replacing Fuses

There are two fuses located on the logic board, two fuses located on the filter board, and two fuses located on the motor power supply board.

To replace the fuses:

1. Disconnect power to the fixture. If the fixture has been operating, allow the fixture to cool before handling.
2. Determine which fuse to replace by referring to the following table.

Fuse	Type and Rating	Size	Protects	Symptom of Failure
Logic Board F1	2.5 A, 250 V, Slow Blow only	5mm x 20mm	Pan motor and Tilt motor	Pan and Tilt will no longer function.
Logic Board F2	2.5 A, 250 V, Slow Blow only	5mm x 20mm	Other motors and fans	Wheels will no longer function, and fans will shut off.
Motor Power Supply Board F1	6.3 A, 250 V, Slow Blow only	5mm x 20mm	Motor Power Supply Board	Motors will not move, lamp is off, and fixture appears dead.
Motor Power Supply Board F2	6.3 A, 250 V, Fast Blow only	5mm x 20mm	Logic Board and motors	Motors will not move, lamp is off, and fixture appears dead.

Fuse	Type and Rating	Size	Protects	Symptom of Failure
Filter Board F1	16 A, 250 V, Fast Blow only	5mm x 20mm	Entire fixture	Motors will not move, lamp is off, and fixture appears dead.
Filter Board F2	16 A, 250 V, Fast Blow only	5mm x 20mm	Entire fixture	Motors will not move, lamp is off, and fixture appears dead.

- Using a wide-tip, flat head screwdriver, loosen the two panel cover retaining screws on each side of the fixture.
- Remove the fixture's two panel covers by sliding them off the fixture.

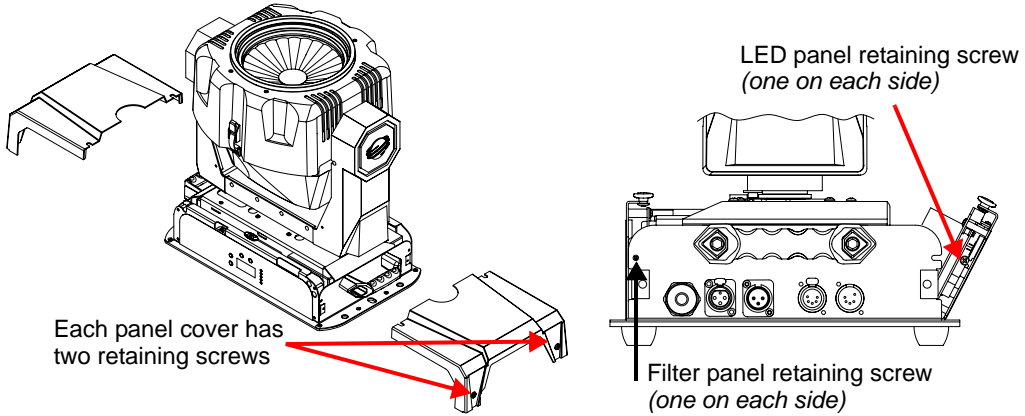

- To access the **logic board fuses** or the **motor power supply board fuses**, use a #2 Phillips-head screwdriver to loosen (*but do not remove*) the two retaining screws on either side of the LED display panel.

If you want to access the **filter board fuses**, use a #2 Phillips-head screwdriver to loosen (*but do not remove*) the two filter panel retaining screws.

- Gently lower the desired panel(s).
- From the LED display panel side of the fixture, disconnect the motor power supply cable from the logic board.

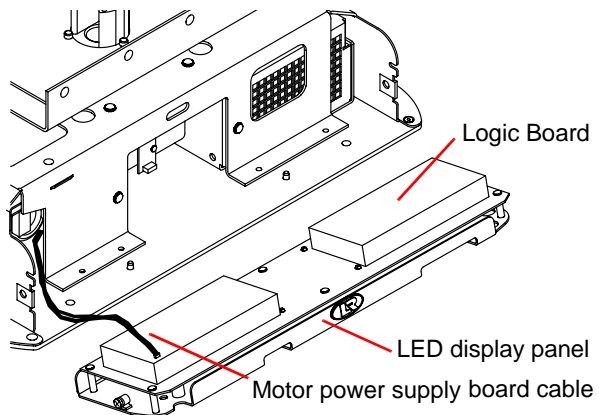

8. From the filter panel side of the fixture, Disconnect the Ground (green wire), L1 (blue wire), and L2 (brown wire) from the motor power supply board.

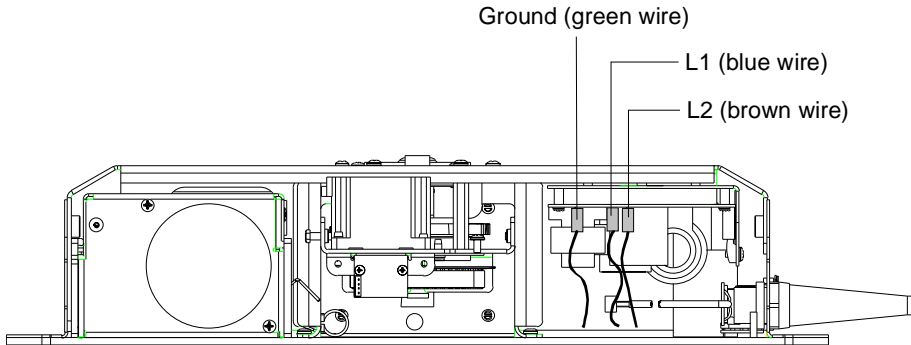

9. Use a #2 Phillips-head screwdriver to remove the three screws (A) and slide the motor power supply board assembly (B) out of the fixture.
10. Locate the fuse(s) to be replaced and replace with a fuse of the same type and rating.

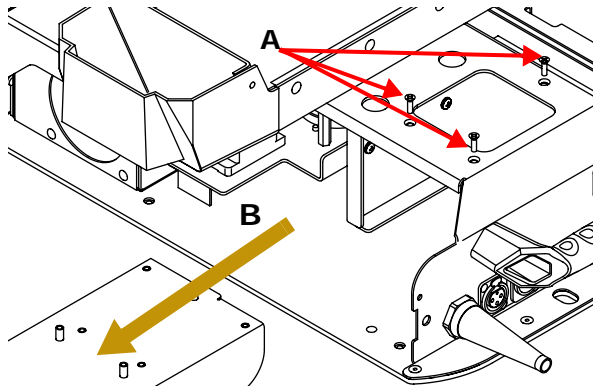

Motor Power Supply Board

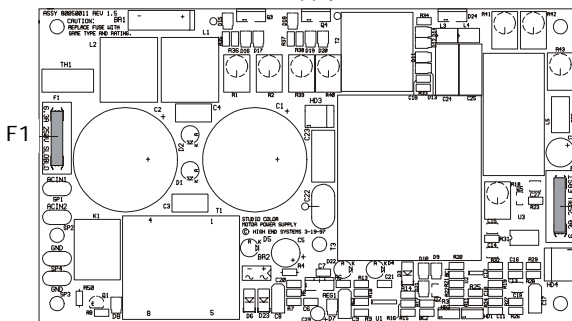

Filter Board

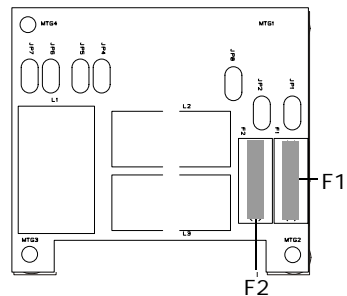

Logic Board

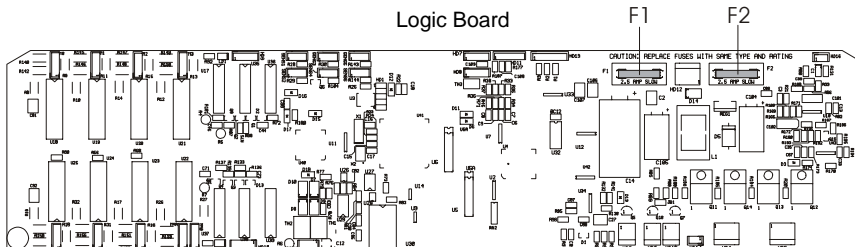

Note: *If you are replacing the fuses on the LED display panel or the filter panel, you must first remove the protective plastic covering over the fuse(s).*

If applicable, reinstall the protective plastic covering over the fuse.

11. If you removed the motor power supply board assembly, replace the assembly in the fixture and reinstall the three screws.
12. Reconnect the Ground, L1, and L2 wires to the motor power supply board.
13. Reconnect the motor power supply cable to the logic board.
14. Return the filter panel and/or the LED display panel to the original, upright position and tighten the display panel retaining screws.
15. Replace the two panel covers and tighten the four panel cover retaining screws.

Replacing the Lamp



Warnings: Disconnect power before re-lamping or servicing.



An operating, unshielded MSR lamp emits ultraviolet and visible (UV-vis) radiation which could damage eyes and skin. Whenever you are working on or near an exposed lamp, wear protective eye gear. Never look directly at the lamp while the lamp is on.



Hot lamp may be an explosion hazard. Do not open for five minutes after switching off. Wear eye and hand protection when re-lamping.



Caution: This equipment is designed for use with specified. Use of any other type lamp may be hazardous and may void the warranty.

You will need:

- appropriate lamp for your Studio Command Model (see *Lamp Specifications* on page 7),
- protective gloves and eyewear
- wide tip, flat head screwdriver

To replace the lamp:

1. Disconnect power to fixture.

If the fixture has been operating, wait for the lamp to cool before handling.

2. Put on protective eyewear and gloves.

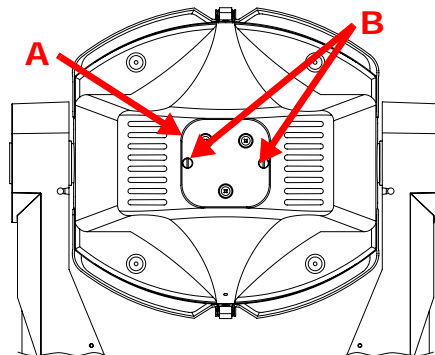

Lamp cap and assembly screws.

3. Tilt the fixture's head to access the lamp cap **[A]** and using a wide tip, flat head screwdriver, loosen (but do not remove) the two lamp assembly screws **[B]**.
4. Pull the lamp assembly straight out of the fixture **[C]**. The lamp assembly is connected to the fixture by lamp socket wires. Support the lamp assembly while replacing the lamp. **Do not allow the lamp socket wires to support the weight of the lamp assembly.**

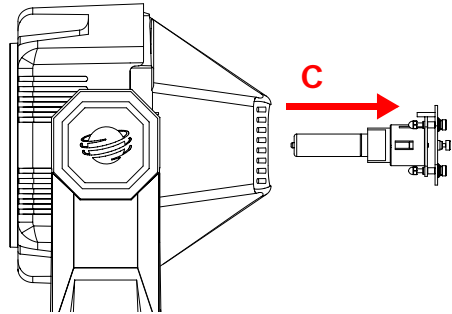

5. Holding the existing lamp by its ceramic base, carefully pull the lamp straight out of the lamp socket **[D]**.



Caution: Do not squeeze the lamp glass while removing the existing lamp from the socket. Lamp glass may shatter.

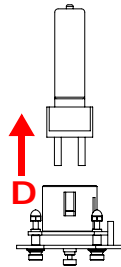

6. Remove all packaging materials from the new lamp. Holding the new lamp by its ceramic base, gently press the two base pins into the lamp socket until the lamp is firmly seated.



Caution: When handling the new lamp, avoid contact with the lamp glass. If the lamp glass is soiled by oil or dirt from skin, gloves, etc., clean the cold lamp glass with an alcohol wipe. A soiled lamp could overheat and burst, causing damage to the fixture.

7. Re-insert the lamp assembly straight into the fixture.



Caution: Make sure the lamp socket wires are not wrapped around the lamp or crimped while reinserting the lamp assembly.

8. Tighten the lamp assembly screws.
9. Reset the lamp hours to zero so that you can track the lamp life (see *Resetting Lamp Hours (L/RS)* (Studio Command 1200/700 models only) on page 40).
10. Optimize the new lamp.

Optimizing the Lamp

You should optimize the lamp after you replace the lamp, or if you notice a “hot spot” of brightness anywhere other than the center of the light beam.

To complete the optimization procedure below, you can use either the fixture's on-board menu system or your DMX controller.

1. Orient the fixture so that the beam will project onto a flat, white surface at least 10 feet (3 m) away.
2. Turn the lamp on using the Menu system (see *Turning the Lamp On or Off (LAMP)* on page 33) or with a console via DMX.

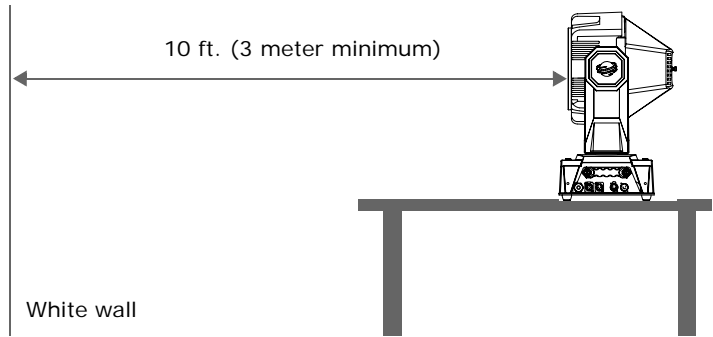

3. Make sure that the light beam is round and not oval.
4. If necessary, use the following steps in the menu to adjust the pan and tilt construct values until the beam is round, or set Pan and Tilt values via a DMX console.

AddR Press and hold <Menu> until AddR appears on the LED display.

PRST Scroll to the *PRST* menu. Press <Enter> to select.

EDIT Scroll to the *EDIT* menu. Press <Enter> to select.

SN01 Scroll to a scene number (*SN01–SN16*).

to

SN16 Press <Enter> to store.

Select a Pan Value (PAN):

PAN Scroll to the *PAN* parameter. Press <Enter> to select.

+30.5 Scroll to a pan value from -49.9 to +49.9 (in this example, +30.5).
Press <Enter> to store the selection.

Select a Tilt Value (TILT):

TILT Scroll to the *TILT* parameter. Press <Enter> to select.

-20.3 Scroll to the desired tilt value from -49.9–+49.9 (in this example, -20.3).
Press <Enter> to store the selection.

5. Locate and loosen the three lamp optimization screws **[A]**.
6. Look at the wall where the beam is projected and use the three optimization screws to adjust the lamp's position within the fixture. until the beam is at its maximum brightness and the light level is even across the beam (or the "hot spot" of brightness is at the center of the beam).

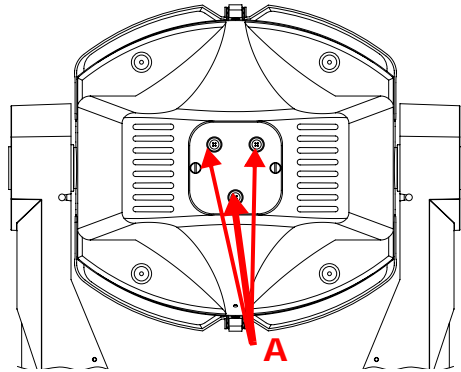

Motor Gear Maintenance

Lubricating the motor gears with each lamp replacement will significantly extend gear life. Referring to the figure below:

1. Unlatch and remove bezel.
2. Remove 2 screws **[A]** and lift the Dim/Shutter motor light shield **[B]**.
3. Tilt the module to access the gear for each motor **[C]** and, supporting the gear, carefully apply Krytox lubricant.



Caution: Using too much force in applying lubricant can bend and damage gear.

4. Replace shield and bezel.

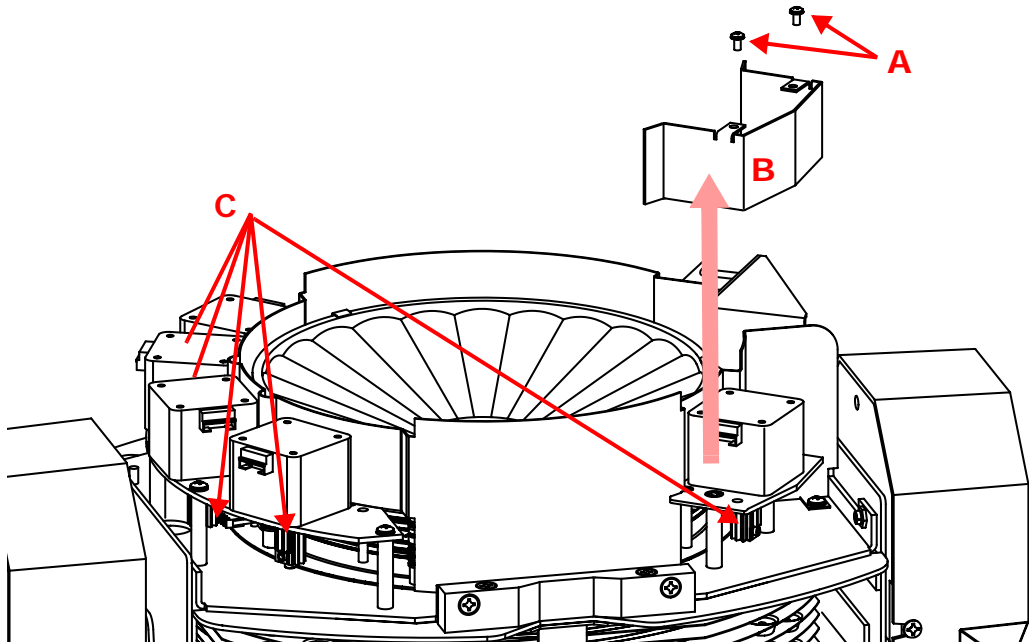

Chapter 6:

Troubleshooting

This chapter lists typical symptoms and solutions for problems you might experience when using your Studio Command™ fixture. If the problem you are experiencing is not listed in this chapter or the solution listed does not solve the problem, contact High End Systems customer service:

Customer Service

High End Systems, Inc.
 2105 Gracy Farms Lane
 Austin, TX 78758 USA
 voice: 800.890.8989
 fax: 512.834.9195
 toll free: 800.890.8989

Alphanumeric Display Error Messages

The front panel on Studio Command fixtures has an alphanumeric LED (Light Emitting Diode) display, five status LEDs, and four menu navigation buttons.

Under normal circumstances, the alphanumeric display cycles between displaying the fixture's name (CMNd), the fixture type (700 for the Studio Command standard model or H for Studio Command-H model) the fixture software version (Vxxx), and the fixture's DMX start channel (Cxxx). However, if you are experiencing problems with your fixture, the status LEDs and/or alphanumeric display can also provide insight on where the problem is originating.

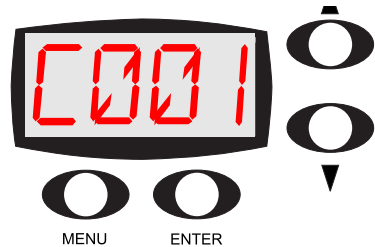

The following table lists alphabetically the Error Messages Studio Command fixtures can display along with the problem(s) each may indicate and potential solutions.

Display Message	Problem	Solution
BOOT DIFF	The fixture's normal boot code does not match the backup boot code.	Update the boot code (see <i>Copying the Boot Code (BOOT)</i> on page 33).
EMEM CHNL	The fixture lost the assigned DMX start channel and will automatically default to DMX start channel 1.	To reassign the DMX start channel, see <i>Assigning a DMX Start Channel</i> on page 18.

Display Message	Problem	Solution
EMEM DINV	The fixture lost the display invert setting and will default to non-inverted	To restore display invert setting, see <i>Inverting LED Characters (D/IN)</i> on page 28.
EMEM DLOS	The fixture lost the DMX data loss setting and will default to short mode.	To reassign the DMX data loss setting, see <i>Data Loss Shutter Close (DLOS)</i> on page 29).
EMEM DPLY	The fixture lost the display setting and will default to on and bright.	To restore the display setting, see <i>Changing the Display Output (DSPL)</i> on page 28.
EMEM FHRS	The fixture lost the number of fixture hours and will default to zero.	Not Applicable.
EMEM LHRS	The fixture lost the number of lamp hours and will default to zero (700 model only).	Not Applicable.
EMEM LMPL	The fixture lost the lamp life limitation setting and will default to unlimited lamp life. (700 model only)	If the fixture was set to lamp life limitation, reassign the lamp life setting (see <i>Setting the Lamp Warning Message (LMPL)</i> on page 29).
EMEM L/ST	The fixture lost the number of lamp strikes and will default to zero (700 model only).	Not Applicable.
EMEM MODE	The fixture lost the mode setting (DMX control or preset playback) and will default to DMX control.	To reassign the mode setting, see <i>Setting Preset Playback (PLAY)</i> on page 23.
EMEM PINV	The fixture lost the pan invert setting and will default to non-inverted.	To reassign the pan invert setting, see <i>Inverting Pan (P/IN)</i> on page 27.
EMEM SWAP	The fixture lost the pan/tilt swap setting and will default to non-swapped.	To enable pan/tilt swap (see <i>Swapping Pan and Tilt (SWAP)</i> on page 26).
EMEM TINV	The fixture lost the tilt invert setting and will default to non-inverted.	To reassign tilt invert setting (see <i>Inverting Tilt (T/IN)</i> on page 27).
EMEM TMOD	The fixture lost the test mode setting (<i>Factory Use Only</i>) and defaults to normal operation.	Not Applicable.
EMEMU SER	The fixture lost the assigned user setting and will automatically default to user A.	To reassign the user setting (see <i>Setting the User Type (USER)</i> on page 30).
ERSE FLSH	One or more fixtures on the data link has failed to erase the FlashROM in a suitable amount of time.	Attempt another software crossload (see <i>Crossloading Fixture Software (XLD)</i> on page 32). Contact High End Systems customer support if problem continues.

Display Message	Problem	Solution
HEAD TEMP	<p>Fixture head temperature has exceeded the maximum permissible level due to:</p> <ul style="list-style-type: none"> • a bad fan • excessive ambient temperatures • blockage in fan vents on back of the fixture head • a broken wire connecting the fan to the logic board. <p>The fixture automatically turns the lamp and motors off.</p>	<p>Reduce the ambient temperature around the fixture and/or remove any blockage from the fixture's fan vents.</p> <p>Contact High End Systems customer support (see <i>page ii</i>) if problem continues.</p>
LAMP LIFE	<p>The fixture's lamp life limitation setting was enabled and the current lamp has exceeded 900 hours.</p>	<p>This message is only a warning. Take no action unless this message changes to "LAMP OUT."</p>
LAMP MISS	<p>The fixture cannot detect the temperature readback from the thermometer in the fixture head.</p> <p>The lamp cap is not installed on the fixture.</p> <p>There is a broken wire or loose connector between the thermometer and the logic board.</p> <p>The lamp interlock in the head has failed.</p>	<p>Make sure lamp cap is installed on the fixture (see <i>Replacing the Lamp</i> on page 58). The lamp will not strike if the lamp plate is removed. If the lamp is on when the lamp plate is removed, the lamp is extinguished. If the lamp was on when the lamp plate was removed, the lamp strikes again 30 seconds after the lamp plate is reinstalled.</p> <p>Contact High End Systems customer support if problem continues.</p>
LAMP OUT	<p>The fixture's lamp life limitation setting was enabled and the current lamp has exceeded 1000 hours. The fixture can no longer strike the lamp.</p>	<p>Replace the lamp (see <i>Replacing the Lamp</i> on page 58) and reset the lamp hours (see <i>Resetting Lamp Hours (L/RS) (Studio Command 1200/700 models only)</i> on page 40).</p>
LAMP STAT	<p>Because of an unexpected electrical event, the fixture cannot determine the current status of the lamp.</p>	<p>Home the fixture (see <i>Homing the Fixture (HOME)</i> on page 33).</p> <p>Contact High End Systems customer support if problem continues.</p>
LAMP TOUT	<p>The fixture has unsuccessfully attempted to strike the lamp.</p>	<p>Allow the fixture to cool, then attempt to manually strike the lamp (see <i>Turning the Lamp On or Off (LAMP)</i> on page 33).</p> <p>Replace the lamp (see <i>Replacing the Lamp</i> on page 58).</p> <p>Contact High End Systems customer support if problem continues.</p>

Display Message	Problem	Solution
LINK BUSY	Two fixtures on the same link are both attempting to transmit data during preset playback or software crossloads.	Disconnect any controllers, bypass any serial data distributors and/or data line optoisolators, and bypass or make sure that any fixtures using RS-422 communications (such as Dataflash [®] AF1000 xenon strobes and Intellabeam [®] fixtures) are located <i>after</i> the Studio Command fixtures on the link. These devices block communication with any other Studio Command fixtures on the link.
LINK EMTY	The fixture is attempting to crossload software but cannot find any suitable fixtures on the data link.	Make sure that all data cables are functioning and that all receiving fixtures are connected to the data cable and powered on. Contact High End Systems customer support if problem continues.
PAN ENCD	The fixture has detected a pan error and cannot correct its position due to a: <ul style="list-style-type: none"> • physical obstruction • broken belt • bad pan encoder • bad encoder wheel • broken wire connecting the encoder to the logic board 	Remove the object (externally or internally) that is blocking the fixture's pan movement and home the fixture (see <i>Homing the Fixture (HOME)</i> on page 33). Contact High End Systems customer support if problem continues.
PAN SENS	The fixture cannot find the pan home slot due to a possible: <ul style="list-style-type: none"> • broken belt • faulty motor • faulty motor driver • broken wire connecting the sensor or pan motor to the logic board • bad sensor 	Contact High End Systems customer support.
PCB TEMP	The temperature in the top box has exceeded the maximum permissible level due to a possible: <ul style="list-style-type: none"> • bad fan • excessive ambient temperatures • blockage in the fan vents • broken wire connecting the fan to the logic board. <p>The fixture will automatically turn the lamp and motors off.</p>	Reduce the ambient temperature around the fixture and/or remove any blockage from the fixture's fan vents. Contact High End Systems customer support if problem continues.
PRST LOST	The fixture failed to read preset data from non-volatile memory.	Reassign the preset scenes' construct values (see <i>Editing or Creating an On-Board Memory Scene (EDIT)</i> on page 24).

Display Message	Problem	Solution
PRGM TIME	One or more fixtures on the data link has failed to program the FlashROM in a suitable amount of time.	Attempt another software crossload (see <i>Crossloading Fixture Software (XLD)</i> on page 32). Contact High End Systems customer support if problem continues.
TMP1 LOST	The fixture cannot detect the temperature readback from the thermometer on the PCB.	Contact High End Systems customer support.
TILT ENCD	Fixture has detected a tilt error and cannot correct its position due to a: <ul style="list-style-type: none"> • physical obstruction • broken belt • bad tilt encoder or encoder wheel • a broken wire connecting the encoder to the logic board. 	Remove the object (externally or internally) that is blocking the fixture's tilt movement and home the fixture (see <i>Homing the Fixture (HOME)</i> on page 33). Contact High End Systems customer support if problem continues.
TILT SENS	Fixture cannot find the tilt home slot due to a: <ul style="list-style-type: none"> • broken belt • faulty motor or motor driver • broken wire connecting the sensor or tilt motor to the logic board • bad sensor. 	Contact High End Systems customer support.
UPLD	The software upload or crossload was interrupted and the fixture is held in boot mode.	Make sure the fixture is properly connected to both data and power cables, then attempt another software crossload (see <i>Crossloading Fixture Software (XLD)</i> on page 32). Contact High End Systems customer support if problem continues.

Status LEDs

Studio Command™ fixtures have five Status LEDs on the display panel. The status LEDs help analyze problems with the Studio Command fixture

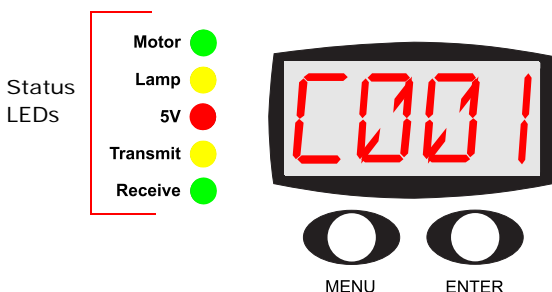

LED	State	Problem Indication?	Description
Motor	solid green	No	The motor power supply is receiving adequate voltage.
	OFF	Yes	Fuse or power failure.
Lamp (700 model)	solid yellow	No	Lamp power is on. Lamp is striking. The lamp power supply is receiving the proper voltage, and the lamp is on.
	OFF	Sometimes ¹	The lamp is extinguished.
Lamp (H model)	solid yellow	No	Lamp circuit is closed
	OFF		Lamp circuit is open
5V	solid red	No	The logic board is receiving the required voltage.
	OFF	Yes	Fuse or power failure.
Transmit	solid yellow	No	Fixture is crossloading software to other fixtures on the link.
	OFF	Sometimes ²	DMX 512 data is not being transmitted.
	flashing	No	The fixture is in preset playback mode, and is the master fixture or the fixture is a slave fixture receiving an upload.
Receive	solid or (flickering green)	No	The fixture is receiving data.
	OFF	Sometimes ²	DMX 512 data is not being received.

¹ If you shut down the lamp using a remote shutdown command, the lamp and the Lamp LED will shut off normally. However, if you have bad data cables, no data cables/controller connected to the fixture, or the controller is off, the lamp and its LED will also be off. If correcting these problems does not turn the lamp on, see the next section.

² Neither the Transmit nor the Receive LED will be on until you have connected the fixture to a DMX 512-compatible controller using XLR data-grade cabling. If these LEDs remain OFF even though you have connected the fixture to a controller and are sending DMX 512 commands to the fixture, see the next section.

General Troubleshooting

Use the following table to find solutions to general fixture problems not indicated by alphanumeric LED display error messages or status LEDs.

Problem	Probable Cause	Solution
Fixture will not power on.	No power is connected.	Connect power to the fixture.
	Fuse is bad.	Check the power supply fuses (see <i>Replacing Fuses</i> on page 55).
	Power connectors are bad.	Contact High End Systems customer support.
Fixture functions but lamp does not strike.	The lamp is bad.	Replace the lamp (see <i>Replacing the Lamp</i> on page 58).
	The lamp is currently too hot to strike. (700 model only)	Provide correct power source voltage, power cord cap, and input voltage setting (see <i>Installing an Attachment Plugs</i> on page 9). Allow the lamp to cool, then restrike the lamp (see <i>Turning the Lamp On or Off (LAMP)</i> on page 33).
	The Ignitor connection is loose. (700 model only)	Contact High End Systems customer support.
Lamp is dimmer than other fixtures.	<ul style="list-style-type: none"> The lamp is bad or old. The wrong type of lamp is installed. 	Replace lamp with the specified type (see <i>Replacing the Lamp</i> on page 58).
	The lamp is not optimized.	Optimize the lamp (see <i>Optimizing the Lamp</i> on page 59).
Lamp shuts off during operation.	The lamp is bad.	Replace the lamp (see <i>Replacing the Lamp</i> on page 58).
	The fixture has exceeded the maximum temperature.	Allow the fixture 5 to 10 minutes to cool, then attempt to strike the lamp (see <i>Turning the Lamp On or Off (LAMP)</i> on page 33).
	The lamp socket is loose and causing arcing.	Contact High End Systems customer support.
Fixture not homing properly.	A sensor, driver, or motor is faulty.	Contact High End Systems customer support).
Color system is not producing the correct color.	The fixture is not properly homed.	Home the fixture (see <i>Control Parameter</i> on page 53 for controller Homing or <i>Homing the Fixture (HOME)</i> on page 33 to Home the fixture manually.) Contact High End Systems customer support if problem continues.

Problem	Probable Cause	Solution
Fixture is not responding to controller commands or is producing unexpected results.	The data cable is faulty.	Test and replace the data cables as necessary.
	No controller is attached to the link or the controller is not generating any output.	Verify that a controller is connected to the link and is generating output by sending commands to a known working device.
	The fixture has an incorrect fixture number or DMX start channel.	Verify the fixture number or DMX start channel does not overlap another fixture's DMX start channel (see <i>Uploading Latest Fixture Software</i> on page 17).
	The link was not terminated.	Terminate the link (see <i>Terminating the Link</i> on page 16).
	The logic board has been replaced and not configured correctly for this model.	Set the sensor positions according to the table at the bottom of this page.
Pan or Tilt position is off.	The pan and tilt is out of home.	Home the fixture (see <i>Control Parameter</i> on page 53 or <i>Homing the Fixture (HOME)</i> on page 33). Contact High End Systems customer service
Display is not functioning.	The LED display is set off.	Turn the LED display on (see <i>Changing the Display Output (DSPL)</i> on page 28).
	The power supply fuse is bad.	Check the power supply fuses (see <i>Replacing Fuses</i> on page 55).
	The power connectors are loose.	Re-seat the power connectors and turn the LED display on.
	The software upload was incomplete.	At fixture start-up, press the two navigational arrow buttons simultaneously. The LED will display "UPLD" and hold the fixture in boot mode. Reload the latest version of the software.
	The logic board is bad.	Contact High End Systems customer service.

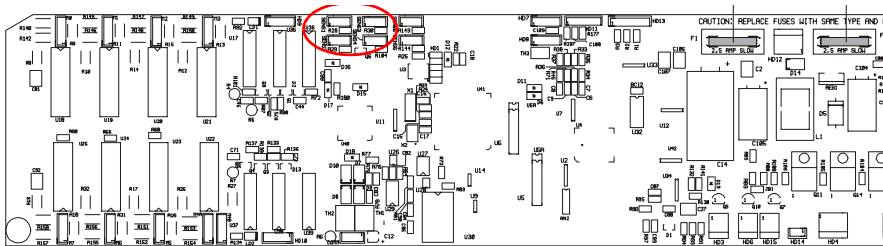

	Sensor Position			
	1	2	3	4
Studio Command 700 with KT56	Open	Open	Open	Open
Studio Command 700 with KT60	Jumper	Jumper	Jumper	Jumper
Studio Command H	Jumper	Open	Open	Open

Upload and Crossload Troubleshooting

The following table describes solutions to problems encountered while uploading or crossloading new software versions.

Problem	Probable Cause	Solution
Not all fixtures on the link are receiving the upload.	Fixture(s) are off	Power on the fixture(s)
	Bad cable(s)	Test and replace cable(s) as necessary
	Cable(s) disconnected	Reconnect cable(s)
	Controllers, serial data distributors, data line Optoisolators, or fixture(s) using RS-422 communication is connected <i>before</i> Studio Command fixtures on the link.	Remove or bypass any incompatible devices from the data link or move them to a link position <i>after</i> the Studio Command fixtures.
Lighting controller is not able to erase FlashROM.	The XLR cable(s) disconnected	Reconnect XLR cable(s)
	Bad cable(s)	Replace cable(s)
	The fixture's electrical circuitry is damaged	Contact High End Systems customer support.
Lighting controller does not recognize a fixture at the assigned address	Lighting desk was configured with a fixture at that address, but no fixtures were found there.	<ul style="list-style-type: none"> • If there is not a fixture at that address, ignore this message - if there is a fixture at that address, verify the fixture number/DMX start channel. • Check connections. • Check to ensure fixture is turned on.
	Controllers, serial data distributors, data line optoisolators, or fixture(s) using RS-422 communication is connected <i>before</i> Studio Command fixtures on the link.	Remove or bypass the offending devices from the data link or move them <i>after</i> the Studio Command fixtures.
The fixture's LED displays: BOOT DIFF ERR	New software included a new boot code.	Accept and store the new boot code (see <i>Copying the Boot Code (BOOT)</i> on page 33).
Fixtures are not crossloading.	Controllers, serial data distributors, data line Optoisolators, or fixture(s) using RS-422 communication is connected <i>before</i> Studio Command fixtures on the link.	Remove or bypass any offending devices from the data link or move them <i>after</i> the Studio Command fixtures.

Appendix A:

Studio Command™ DMX Protocol

Studio Command I200 Protocol

Channel	Parameter	Description	Value (dec.)	Value (%)	Value (hex)
1	Pan	Pan, coarse adjustment	0-255	0-100	00-FF
2	Pan	Pan, fine adjustment	0-255	0-100	00-FF
3	Tilt	Tilt, coarse adjustment	0-255	0-100	00-FF
4	Tilt	Tilt, fine adjustment	0-255	0-100	00-FF
5	Color Function	Full Speed Control			
		Continuous	0-15	0-6	00-0F
		Cycle (Speed is set by the Cyan channel)	16-31	6-12	10-1F
		Random (Speed is set by the Cyan channel)	32-47	13-18	20-2F
		TBD	48-127	19-50	30-7F
		MSpeed Controlled			
		Continuous	128-143	50-56	80-8F
		Cycle (Speed is set by the Cyan channel)	144-159	57-62	90-9F
		Random (Speed is set by the Cyan channel)	160-175	63-69	A0-AF
		TBD	176-255	69-100	B0-FF
6	Cyan Wheel	Continuous Mode. Absolute position across 360 degrees			
		Cyan Full Saturation	0	0	00
		Open	255	100	FF
		Cycle & Random Modes <i>(sets the rate for all color wheels when Color function parameter = 16-47)</i>			
		Slow Rate	0	0	00
		Fast Rate	255	100	FF
7	Magenta Wheel	Magenta Full Saturation	0	0	00
		Open	255	100	FF
8	Yellow Wheel	Yellow Full Saturation	0	0	00
		Open	255	100	FF
9	Zoom	Zoom Narrow	0	0	00
		Zoom Wide	255	100	FF

Channel	Parameter	Description	Value (dec.)	Value (%)	Value (hex)
10	Shutter Function	Normal Shutter Functions (No lamp or dimming functions selected in Control channel)			
		Close	0-23	0-9	00-17
		Periodic Strobe, Mechanical from 1-4Hz operation	24-27	9-10	18-1B
		Periodic Strobe, Electronic from 5-33Hz operation	28-49	11-19	1C-31
		Random Random Strobe	50-75	20-29	32-4B
		Synchronous Random Strobe	76-101	30-40	4C-65
		Open	102-255	41-100	66-FF
		Lamp Assisted Strobes (Accessed when the Control channel range = 134-137)			
		<i>The shutter functions are the same as in the normal shutter function range. Periodic random random and random synchronous strobes are lamp assisted.</i>			
		Lamp functions. (Accessed when the Control channel range = 138-141)			
		<i>The shutter functions are the same as in the normal shutter function range. Periodic random random and random synchronous strobes are lamp assisted.</i>			
		Lamp Dimming only. (Accessed when the Control Channel range = 146-149)			
		<i>The shutter functions are the same as the normal shutter function range. Dimming is accomplished electronically, lowering the lamp power. Dimming will not go to black. Strobes are mechanical and will go to black.</i>			
		11	Dim	Close	0
Open	255			100	FF
12	MSpeed	Disable	0-3	0-1	00-03
		Longest (252.7 sec.)	4	2	04
		Shortest (0.15 sec.)	255	100	FF
13	Macro Note 1)	Macro Off	0-5	0-2	00-05
		Pan sweep, small to large angle	6-62	2-24	06-3E
		Macro Off	63-65	25-25	3F-41
		Tilt sweep, small to large angle	66-122	26-48	42-7A
		Macro Off	123-125	48-49	7B-7D
		Clockwise circle, small to large	126-160	49-63	7E-A0
		Macro Off	161-163	63-64	A1-A3
		Counterclockwise circle, small to large	164-198	64-78	A4-C6
		Reserved	199-255	78-100	C7-FF

Channel	Parameter	Description	Value (dec.)	Value (%)	Value (hex)
14	Control	The Control channel should not be crossfaded.			
		Safe (disables all Control settings)	0-9	0-4	00-09
		Pan & Tilt MSpeed Off	10-19	4-7	0A-13
		Set Shutter channel to 0 for access to the following commands.			
		Display Off	20-28	8-11	14-1C
		Display Dim	30-38	12-15	1E-26
		Display Bright	40-48	16-19	28-30
		Home	60-68	24-27	3C-44
		Lamp On	80-88	31-35	50-58
		Lamp Off	90-98	35-38	5A-62
		Shutdown (send for 5 seconds)	120-130	47-51	78-82
		Lamp Functions			
		Lamp assisted strobes (Periodic and Random strobe functions are lamp assisted. Ramp functions are not lamp assisted.)	134-137	53-54	86-89
		Lamp functions (modifies the shutter channel)	138-141	54-55	8A-8D
		Lamp/mechanical dimming (Lamp output will vary from a minimum to 1200 Watts as the mechanical dimming ranges from 0-100%)	142-145	56-57	8E-91
Lamp only dimming (Electronic dimming only from a minimum to 1200 Watts.)	146-149	57-58	92-95		
To be determined	150-255	59-100	96-FF		

Note : *The pan and tilt coarse channels set the center position of the position macro. The Mspeed channel is used to control the speed of the macros*

With the Mspeed set at the default value of DMX 0-4 all internal effects complete moves at approximately 2.5 seconds. This provides a pleasing look for those customers that do not want the additional variation given by using the Mspeed channel.

With the Mspeed set between DMX 5-255 all internal effects complete moves at the selected Mspeed time (up to 25 seconds).

Those fixture types that support On Board Programming also support the Internal Effects as part of the On Board programming features. The Internal Effects will operate as an additional programming parameter labeled MACR.

Studio Command 700 Protocol

Channel	Parameter	Description	Value (dec.)	Value (%)	Value (hex)
1	Pan	Pan, coarse adjustment	0-255	0-100	00-FF
2	Pan	Pan, fine adjustment	0-255	0-100	00-FF
3	Tilt	Tilt, coarse adjustment	0-255	0-100	00-FF
4	Tilt	Tilt, fine adjustment	0-255	0-100	00-FF
5	Color Function	Full Speed Control			
		Continuous	0-15	0-6	00-0F
		Cycle (Speed is set by the Cyan channel)	16-31	6-12	10-1F
		Random (Speed is set by the Cyan channel)	32-47	13-18	20-2F
		TBD	48-127	19-50	30-7F
		MSpeed Controlled			
		Continuous	128-143	50-56	80-8F
		Cycle (Speed is set by the Cyan channel)	144-159	57-62	90-9F
		Random (Speed is set by the Cyan channel)	160-175	63-69	A0-AF
		TBD	176-255	69-100	B0-FF
6	Cyan Wheel	Continuous Mode. Absolute position across 360 degrees			
		Cyan Full Saturation	0	0	00
		Open	255	100	FF
		Cycle & Random Modes (sets the rate for all color wheels when Color function parameter = 16-47)			
		Slow Rate	0	0	00
		Fast Rate	255	100	FF
7	Magenta Wheel	Magenta Full Saturation	0	0	00
		Open	255	100	FF
8	Yellow Wheel	Yellow Full Saturation	0	0	00
		Open	255	100	FF
9	Zoom	Zoom Narrow	0	0	00
		Zoom Wide	255	100	FF
10	Shutter Function	Normal Shutter Functions (No lamp or dimming functions selected in Control channel)			
		Close	0-23	0-9	00-17
		Periodic Strobe, Mechanical from 1-4Hz operation	24-27	9-10	18-1B
		Periodic Strobe, Electronic from 5-33Hz operation	28-49	11-19	1C-31
		Random Random Strobe	50-75	20-29	32-4B
		Synchronous Random Strobe	76-101	30-40	4C-65
		Ramp Open / Snap Shut	102-127	40-50	66-7F
		Snap Open / Ramp Shut	128-153	50-60	80-99
		Ramp Open / Ramp Shut	154-179	60-70	9A-B3
		Random Ramp Open / Snap Shut	180-205	71-80	B4-CD
		Random Snap Open / Ramp Shut	206-231	81-91	CE-E7
		Open	232-255	91-100	E8-FF

Channel	Parameter	Description	Value (dec.)	Value (%)	Value (hex)
10	Shutter (cont.)	Lamp Assisted Strobes (Accessed when the Control channel range = 134-137)			
		<i>The shutter functions are the same as in the normal shutter function range. Periodic strobes, random random and random synchronous strobes are lamp assisted.</i>			
		Lamp Functions. (Accessed when the Control channel range = 138-141)			
		<i>For lamp boost effects, the lamp is boosted above the 700 Watt level for the specified period of time. The lamp is also boosted during the lightning effects.</i>			
		<i>Before another boost or lightning effect can occur, the shutter channel must be moved to either closed or open, or the control channel must be moved outside the lamp function range.</i>			
		<i>Boost functions to black will boost the lamp for the specified time then close the shutter. Boost functions to white will boost the lamp for the specified time, then leave the shutter open with the lamp dimmed.</i>			
		<i>When lightning functions are selected, the dim channel scales the overall brightness of the lightning stroke. Dim at 255 will yield maximum brightness.</i>			
		Close	0-23	0-9	00-17
		Periodic lamp strobes	24-49	9-19	18-31
		Random random lamp strobes	50-75	20-29	32-4B
		Synchronous random lamp strobes	76-101	30-40	4C-65
		Boost lamp 1.0 second, black	102-105	40-41	66-69
		Boost lamp .75 second, black	106-109	42-43	6A-6D
		Boost lamp .66 second, black	110-113	43-44	6E-71
		Boost lamp .5 second, black	114-117	45-46	72-75
		Boost lamp .33 second, black	118-121	46-47	76-79
		Boost lamp .25 second, black	122-127	48-50	7A-7F
		Boost lamp 1.0 second, white	128-131	50-51	80-83
		Boost lamp .75 second, white	132-135	52-53	84-87
		Boost lamp .66 second, white	136-139	53-55	88-8B
		Boost lamp .5 second, white	140-143	55-56	8C-8F
		Boost lamp .33 second, white	144-147	56-58	90-93
		Boost lamp .25 second, white	148-153	58-60	94-99
		Lightning strike 1	154-157	60-62	9A-9D
		Lightning strike 2	158-161	62-63	9E-A1
		Lightning strike 3	162-165	64-65	A2-A5
		Lightning strike 4	166-169	65-66	A6-A9
		Lightning strike 5	170-173	67-68	AA-AD
		Lightning strike 6	174-179	68-70	AE-B3
		To be determined, default black	180-231	71-91	B4-E7
Open	232-255	91-100	E8-FF		
		Lamp Dimming only. (Accessed when the Control Channel range = 146-149)			
		<i>The shutter functions are the same as the normal shutter function range. Dimming is accomplished electronically, lowering the lamp power. Dimming will not go to black. Strobes are mechanical and will go to black.</i>			

Channel	Parameter	Description	Value (dec.)	Value (%)	Value (hex)
11	Dim	Close	0	0	00
		Open	255	100	FF
12	MSpeed	Disable	0-3	0-1	00-03
		Longest (252.7 sec.)	4	2	04
		Shortest (0.15 sec.)	255	100	FF
13	Macro (Note 1)	Macro Off	0-5	0-2	00-05
		Pan sweep, small to large angle	6-62	2-24	06-3E
		Macro Off	63-65	25-25	3F-41
		Tilt sweep, small to large angle	66-122	26-48	42-7A
		Macro Off	123-125	48-49	7B-7D
		Clockwise circle, small to large	126-160	49-63	7E-A0
		Macro Off	161-163	63-64	A1-A3
		Counterclockwise circle, small to large	164-198	64-78	A4-C6
		Reserved	199-255	78-100	C7-FF
14	Control	<i>The Control channel should not be crossfaded.</i>			
		Safe (disables all Control settings)	0-9	0-4	00-09
		Pan & Tilt MSpeed Off	10-19	4-7	0A-13
		<i>Set Shutter channel to 0 for access to the following commands.</i>			
		Display Off	20-28	8-11	14-1C
		Display Dim	30-38	12-15	1E-26
		Display Bright	40-48	16-19	28-30
		Home	60-68	24-27	3C-44
		Lamp On	80-88	31-35	50-58
		Lamp Off	90-98	35-38	5A-62
		Shutdown (<i>send for 5 seconds</i>)	110-130	43-51	6E-82
		<i>Lamp Functions</i>			
		Lamp assisted strobes (Periodic and Random strobe functions are lamp assisted. Ramp functions are not lamp assisted.)	134-137	53-54	86-89
		Lamp functions (modifies the shutter channel)	138-141	54-55	8A-8D
		Lamp/mechanical dimming (Lamp output will vary from a minimum to 700 Watts as the mechanical dimming ranges from 0-100%)	142-145	56-57	8E-91
		Lamp only dimming (Electronic dimming only from a minimum to 700 Watts.)	146-149	57-58	92-95
		To be determined	150-255	59-100	96-FF

Note 1: *The pan and tilt coarse channels set the center position of the position macro. The Mspeed channel is used to control the speed of the macros*

With the Mspeed set at the default value of DMX 0-4 all internal effects complete moves at approximately 2.5 seconds. This provides a pleasing look for those customers that do not want the additional variation given by using the Mspeed channel.

With the Mspeed set between DMX 5-255 all internal effects complete moves at the selected Mspeed time (up to 25 seconds).

Those fixture types that support On Board Programming also support the Internal Effects as part of the On Board programming features. The Internal Effects will operate as an additional programming parameter labeled MACR.

Studio Command-H Protocol

Channel	Parameter	Description	Value (dec.)	Value (%)	Value (hex)
1	Pan	Pan, coarse adjustment	0-255	0-100	00-FF
2	Pan	Pan, fine adjustment	0-255	0-100	00-FF
3	Tilt	Tilt, coarse adjustment	0-255	0-100	00-FF
4	Tilt	Tilt, fine adjustment	0-255	0-100	00-FF
5	Color Function	Full Speed Control			
		Continuous	0-15	0-6	00-0F
		Cycle (Speed is set by the Cyan channel)	16-31	6-12	10-1F
		Random (Speed is set by the Cyan channel)	32-47	13-18	20-2F
		TBD	48-127	19-50	30-7F
		MSpeed Controlled			
		Continuous	128-143	50-56	80-8F
		Cycle (Speed is set by the Cyan channel)	144-159	57-62	90-9F
		Random (Speed is set by the Cyan channel)	160-175	63-69	A0-AF
		TBD	176-255	69-100	B0-FF
6	Cyan Wheel	Continuous Mode. Absolute position across 360 degrees			
		Cyan Full Saturation	0	0	00
		Open	255	100	FF
		Cycle & Random Modes (sets the rate for all color wheels when Color function parameter = 16-47)			
		Slow Rate	0	0	00
		Fast Rate	255	100	FF
		7	Magenta Wheel	Magenta Full Saturation	0
		Open	255	100	FF
8	Yellow Wheel	Yellow Full Saturation	0	0	00
		Open	255	100	FF
9	Zoom	Zoom Narrow	0	0	00
		Zoom Wide	255	100	FF
10	Shutter Function	Open, activate Control channel	0-23	0-9	00-17
		Periodic Strobe	24-49	9-19	18-31
		Random Random Strobe	50-75	20-29	32-4B
		Synchronous Random Strobe	76-101	30-40	4C-65
		Open	102-255	40-100	66-FF
11	MSpeed	Disable	0-3	0-1	00-03
		Longest (252.7 sec.)	4	2	04
		Shortest (0.15 sec.)	255	100	FF

Channel	Parameter	Description	Value (dec.)	Value (%)	Value (hex)
12	Macro (Note 1)	Macro Off	0-5	0-2	00-05
		Pan sweep, small to large angle	6-62	2-24	06-3E
		Macro Off	63-65	25-25	3F-41
		Tilt sweep, small to large angle	66-122	26-48	42-7A
		Macro Off	123-125	48-49	7B-7D
		Clockwise circle, small to large	126-160	49-63	7E-A0
		Macro Off	161-163	63-64	A1-A3
		Counterclockwise circle, small to large	164-198	64-78	A4-C6
		Reserved	199-255	78-100	C7-FF
13	Control	The Control channel should not be crossfaded.			
		Safe (disables all Control settings)	0-9	0-4	00-09
		Pan & Tilt MSpeed Off	10-19	4-7	0A-13
		Set Shutter channel to 0 for access to the following commands.			
		Display Off	20-28	8-11	14-1C
		Display Dim	30-38	12-15	1E-26
		Display Bright	40-48	16-19	28-30
		Home	60-68	24-27	3C-44
		Shutdown (send for 5 seconds)	80-130	31-51	50-82
		To be determined	131-255	52-100	83-FF

Note 1: *The pan and tilt coarse channels set the center position of the position macro. The MSpeed channel is used to control the speed of the macros*

With the MSpeed set at the default value of DMX 0-4 all internal effects complete moves at approximately 2.5 seconds. This provides a pleasing look for those customers that do not want the additional variation given by using the MSpeed channel.

With the MSpeed set between DMX 5-255 all internal effects complete moves at the selected MSpeed time (up to 25 seconds).

Those fixture types that support On Board Programming also support the Internal Effects as part of the On Board programming features. The Internal Effects will operate as an additional programming parameter labeled MACR.

Appendix B:

MSpeed Conversion Table

The following table lists the MSpeed (motor) movement times and their corresponding DMX controller values. If you have a numeric-type controller, use the Value Decimal (dec.) column. If you have a fader-type controller, use the Value Percentage (%) column. If your controller allows you to program hex values, use the Value (hex) column.

Time (sec.)	Value (dec.)	Value (%)	Value (hex)	Time (sec.)	Value (dec.)	Value (%)	Value (hex)	Time (sec.)	Value (dec.)	Value (%)	Value (hex)
0.15	255	100	FF	5.94	217	85	D9	23.30	179	70	B3
0.15	254	100	FE	6.25	216	85	D8	23.92	178	70	B2
0.17	253	99	FD	6.56	215	84	D7	24.54	177	69	B1
0.19	252	99	FC	6.89	214	84	D6	25.17	176	69	B0
0.21	251	98	FB	7.22	213	84	D5	25.80	175	69	AF
0.25	250	98	FA	7.56	212	83	D4	26.45	174	68	AE
0.29	249	98	F9	7.91	211	83	D3	27.10	173	68	AD
0.35	248	97	F8	8.27	210	82	D2	27.76	172	67	AC
0.41	247	97	F7	8.63	209	82	D1	28.43	171	67	AB
0.47	246	96	F6	9.00	208	82	D0	29.11	170	67	AA
0.55	245	96	F5	9.39	207	81	CF	29.80	169	66	A9
0.63	244	96	F4	9.77	206	81	CE	30.49	168	66	A8
0.73	243	95	F3	10.17	205	80	CD	31.19	167	65	A7
0.83	242	95	F2	10.58	204	80	CC	31.90	166	65	A6
0.94	241	95	F1	10.99	203	80	CB	32.62	165	65	A5
1.05	240	94	F0	11.41	202	79	CA	33.34	164	64	A4
1.18	239	94	EF	11.84	201	79	C9	34.08	163	64	A3
1.31	238	93	EE	12.28	200	78	C8	34.82	162	64	A2
1.45	237	93	ED	12.72	199	78	C7	35.57	161	63	A1
1.60	236	93	EC	13.17	198	78	C6	36.33	160	63	A0
1.75	235	92	EB	13.63	197	77	C5	37.09	159	62	9F
1.92	234	92	EA	14.10	196	77	C4	37.87	158	62	9E
2.09	233	91	E9	14.58	195	76	C3	38.65	157	62	9D
2.27	232	91	E8	15.07	194	76	C2	39.44	156	61	9C
2.46	231	91	E7	15.56	193	76	C1	39.44v	156	61	9C
2.66	230	90	E6	16.06	192	75	C0	40.23	155	61	9B
2.86	229	90	E5	16.57	191	75	BF	41.04	154	60	9A
3.07	228	89	E4	17.09	190	75	BE	41.85	153	60	99
3.29	227	89	E3	17.61	189	74	BD	42.68	152	60	98
3.52	226	89	E2	18.14	188	74	BC	43.50	151	59	97
3.76	225	88	E1	18.68	187	73	BB	44.34	150	59	96
4.00	224	88	E0	19.23	186	73	BA	45.19	149	58	95
4.25	223	87	DF	19.79	185	73	B9	46.04	148	58	94
4.52	222	87	DE	20.36	184	72	B8	46.90	147	58	93
4.78	221	87	DD	20.93	183	72	B7	47.77	146	57	92
5.06	220	86	DC	21.51	182	71	B6	48.65	145	57	91
5.34	219	86	DB	22.10	181	71	B5	49.54	144	56	90
5.64	218	85	DA	22.70	180	71	B4	50.43	143	56	8F

Time (sec.)	Value (dec.)	Value (%)	Value (hex)	Time (sec.)	Value (dec.)	Value (%)	Value (hex)	Time (sec.)	Value (dec.)	Value (%)	Value (hex)
51.33	142	56	8E	102.77	95	37	5F	175.24	46	18	2E
52.24	141	55	8D	104.05	94	37	5E	176.92	45	18	2D
53.16	140	55	8C	105.35	93	36	5D	178.61	44	17	2C
54.09	139	55	8H	106.65	92	36	5C	180.30	43	17	2B
55.02	138	54	8A	107.96	91	36	5B	182.01	42	16	2A
55.96v	137	54	89	109.28	90	35	5A	183.72	41	16	29
56.91	136	53	88	110.61	89	35	59	185.44	40	16	28
57.87	135	53	87	111.94	88	35	58	187.17	39	15	27
58.84	134	53	86	113.28	87	34	57	188.90	38	15	26
59.81	133	52	85	114.63	86	34	56	190.65	37	15	25
60.79	132	52	84	115.99	85	33	55	192.40	36	14	24
61.78	131	51	83	117.36	84	33	54	194.16	35	14	23
62.78	130	51	82	118.73	83	33	53	195.92	34	13	22
63.79	129	51	81	120.12	82	32	52	197.70	33	13	21
64.80	128	50	80	121.5v	81	32	51	199.48	32	13	20
65.82	127	50	7F	122.91	80	31	50	201.28	31	12	1F
66.85	126	49	7E	124.31	79	31	4F	203.08	30	12	1E
67.89	125	49	7D	125.73	78	31	4E	204.88	29	11	1D
68.94	124	49	7C	127.15	77	30	4D	206.70	28	11	1C
69.99	123	48	7B	128.58	76	30	4C	208.52	27	11	1B
71.05	122	48	7A	130.02	75	29	4B	210.36	26	10	1A
72.13	121	47	79	134.39	72	28	48	212.19	25	10	19
73.20	120	47	78	135.86	71	28	47	214.04	24	9	18
74.29	119	47	77	137.34	70	27	46	215.90	23	9	17
75.38	118	46	76	138.82	69	27	45	217.76	22	9	16
76.49	117	46	75	140.32	68	27	44	219.63	21	8	15
77.60	116	45	74	141.82	67	26	43	221.51	20	8	14
78.71	115	45	73	143.33	66	26	42	223.40	19	7	13
79.84	114	45	72	144.85	65	25	41	225.30	18	7	12
80.98	113	44	71	146.38	64	25	40	227.20	17	7	11
82.12	112	44	70	147.92	63	25	3F	229.11	16	6	10
83.27	111	44	6F	149.46	62	24	3E	231.03	15	6	0F
84.43	110	43	6E	151.01	61	24	3D	232.96	14	5	0E
85.59	109	43	6D	152.57	60	24	3C	234.90	13	5	0D
86.77	108	42	6C	154.14	59	23	3B	236.84	12	5	0C
87.95	107	42	6B	155.71	58	23	3A	238.79	11	4	0B
89.14	106	42	6A	157.30	57	22	39	240.75	10	4	0A
90.34	105	41	69	158.89	56	22	38	242.72	9	4	09
91.55	104	41	68	160.49	55	22	37	244.70	8	3	08
92.76	103	40	67	162.09	54	21	36	246.68	7	3	07
93.98	102	40	66	163.71	53	21	35	248.68	6	2	06
95.21	101	40	65	165.33	52	20	34	250.68	5	2	05
96.45	100	39	64	166.96	51	20	33	246.68	7	3	07
97.70	99	39	63	168.60	50	20	32	248.68	6	2	06
98.95	98	38	62	170.25	49	19	31	250.68	5	2	05
100.22	97	38	61	171.91	48	19	30	252.68	4	2	04
101.49	96	38	60	173.57	47	18	2F				

Appendix C:

Important Safety Information

Warning: For Continued Protection Against Fire

1. This equipment is designed for use with specified lamps only. Use of any other type lamp may be hazardous and may void the warranty.
2. Do not mount on a flammable surface.
3. Maintain minimum distance of 1.0 meter (3.28 feet) from combustible materials.
4. Replace fuses only with the specified type and rating.
5. Observe minimum distance to lighted objects of 2.0 meter (6.56 feet).
6. This equipment for connection to branch circuit having a maximum overload protection of 20 A.

Warning: For Continued Protection Against Electric Shock

1. If this equipment was received without a line cord plug, attach the appropriate line cord plug according to the following code:
 - brown–live
 - blue–neutral
 - green/yellow–earth
2. In the United Kingdom, the colours of the cores in the mains lead of this equipment may not correspond with the coloured markings identifying the terminals in your plug, proceed as follows:
 - the core which is coloured green and yellow must be connected to the terminal in the plug which is marked with the letter E or by the earth symbol , or coloured green or green and yellow.
 - the core which is coloured blue must be connected to the terminal which is marked with the letter N or coloured black.
 - the core which is coloured brown must be connected to the terminal which is marked with the letter L or coloured red.
3. Class I equipment. This equipment must be earthed.
4. Equipment suitable for dry locations only. Do not expose this equipment to rain or moisture.
5. Disconnect power before re-lamping or servicing.
6. Refer servicing to qualified personnel; no user serviceable parts inside.

Warning: For Continued Protection Against Exposure To Excessive Ultraviolet (UV) Radiation

1. Change shields, and lenses if they have become visibly damaged to such an extent that their effectiveness is impaired, for example by cracks or deep scratches.
2. Never look directly at the lamp while lamp is on.

Warning: For Continued Protection Against Injury To Persons

1. Use secondary safety cable when mounting this fixture.
2. Caution: Hot lamp may be an explosion hazard. Do not open for 5 minutes after switching off. Wear eye and hand protection when re-lamping.
3. Equipment surfaces may reach temperatures up to 160° C (320° F). Allow 5 minutes for cooling before handling.
4. Change the lamp if it becomes damaged or thermally deformed.

Appendice C: Importantes Informations Sur La Sécurité

Mise En Garde: Pour Une Protection Permanente Contre Les Incendies

1. Cet appareil est conçu pour l'usage avec les lampes spécifiées seulement. Son utilisation avec tout autre type de lampe peut être dangereuse et annuler la garantie.
2. Ne pas monter les lampes sur une surface inflammable.
3. Maintenir à une distance minimum de 1.0 mètre de matières inflammables.
4. Ne remplacer les fusibles qu'avec des modèles et valeurs assignées recommandés.
5. Respecter une distance minimum de 2.0 mètre par rapport aux objets éclairés.
6. Cet appareil de connection au circuit comporte une protection contre les surcharges de 20 A.

Mise En Garde: Pour Une Protection Permanente Contre Les Chocs Électriques

1. Si cet équipement est livré sans prise de cable, veuillez connecter la prise de cable correcte selon le code suivant:
 - marron - phase
 - bleu - neutre
 - vert/jaune - terre
2. Débrancher le courant avant de changer les lampes ou d'effectuer des réparations.
3. Cet équipement doit être uniquement utilisé dans des endroits secs. Ne pas l'exposer à la pluie ou l'humidité.
4. À l'intérieur de l'équipement il n'y a pas de pièces remplaçables par l'utilisateur. Confiez l'entretien à un personnel qualifié.
5. Equipement de Classe I. Cet équipement doit être mis à la terre.

Mise En Garde: Pour Une Protection Permanente Contre Des Expositions Excessives Aux Rayons Ultra Violets (UV)

1. Changer les blindages ou les écrans s'ils sont visiblement endommagés au point que leur efficacité aient été altérée, par exemple par des fissures ou de profondes égratignures.
2. Ne jamais regarder directement la lampe quand celle ci est allumée.

Mise En Garde: Pour Une Protection Permanente Contre Les Blessures Corporelles

1. Lors de l'assemblage, utiliser un câble de sécurité secondaire.
2. AVERTISSEMENT: Les lampes chaudes comportent un risque d'explosion. Après l'avoir éteinte, attendre 5 minutes avant de la dégager. Lors du remplacement de la lampe, une protection des yeux et des mains est requise.
3. Les surfaces de l'appareil peuvent atteindre des températures de 160 C. Laisser refroidir pendant 5 minutes avant la manipulation.
4. Changer la lampe si elle est endommagée ou thermiquement déformée.

Anhang C: Wichtige Hinweise Für Ihre Sicherheit

Warnung: Zum Schutz Vor Brandgefahr

1. Diese Ausrüstungen sind für Gebrauch mit angegebenen Lampen nur entworfen. Der Gebrauch irgend eines anderen Lampentyps könnte Sie gefährden und Ihre Garantie außer Kraft setzen.
2. Das Gerät nie auf einer feuergefährlichen Fläche montieren.
3. Stets einen Mindestabstand von 1 Meter zu brennbaren Materialien einhalten.
4. Zum Ersatz nur Sicherungen verwenden, die dem vorgeschriebenen Typ und Nennwert entsprechen.
5. Einen Mindestabstand von 2 Meter zu den angestrahlten Objekten einhalten.
6. Dieses Gerät darf nur an eine Zweigleitung mit einem Überlastungsschutz von höchstens 20 A angeschlossen werden.

Warnung: Zum Schutz Gegen Gefährliche Körperströme

1. Wenn dieses Gerät ohne einen Netzkabelstecker erhalten wurde, ist der entsprechende Netzkabelstecker entsprechend dem folgenden Code anzubringen:
 - Braun - Unter Spannung stehend
 - Blau - Neutral
 - Grün/Gelb - Erde
2. Vor dem Austauschen von Lampen oder vor Wartungsarbeiten stets den Netzstecker ziehen.
3. Diese Geräte sind nur zum Einbau in trockenen Lagen bestimmt und müssen vor Regen und Feuchtigkeit geschützt werden.
4. Servicearbeiten sollten nur von Fachpersonal ausgeführt werden. Das Gerät enthält keine wartungsbedürftigen Teile.
5. Dieses Gerät gehört zur Klasse I. Dieses Gerät muß geerdet werden.

Warnung: Zum Schutz Gegen Übermäßige Ultraviolett (UV)-Bestrahlung

1. Die Schutzabdeckungen, Linsen und der UV-Schutz müssen ausgewechselt werden, wenn sie sichtlich dermaßen beschädigt sind, daß sie ihre Wirksamkeit einbüßen, z.B. infolge von Rissen oder tiefen Kratzern.
2. Nie direkt in die eingeschaltete Lampe schauen.

Warnung: Zum Schutz Vor Verletzungen

1. Verwenden Sie bei der Installation des Beleuchtungskörpers ein zusätzliches Sicherheitskabel.
2. VORSICHT: Bei einer heißen Lampe besteht Explosionsgefahr. Nach dem Abschalten der Netzspannung sollten Sie etwa 5 Minuten warten, bevor Sie das Lampengehäuse öffnen. Schützen Sie beim Auswechseln der Lampen Ihre Hände und tragen Sie eine Schutzbrille.
3. Die Oberflächen des Gerätes können Temperaturen bis zu 160 C erreichen. Vor dem Anfassen stets 5 Minuten lang abkühlen lassen.
4. Falls die Lampe beschädigt oder durch Wärmeeinwirkung verformt ist, muß sie ausgewechselt werden.

Apéndice C: Información Importante De Seguridad

Advertencia: Para Protección Continua Contra Incendios

1. Este equipo se diseña para el uso con lámparas especificadas sólo. El uso de cualquier otro tipo de lámpara podrá resultar peligroso, y podrá anular la garantía.
2. No monte el equipo sobre una superficie inflamable.
3. Mantenga una distancia mínima de materiales combustibles de 1,0 metro.
4. Cambie los fusibles únicamente por otros que sean del tipo y la clasificación especificadas.
5. Guarda una distancia mínima a objetos iluminados de 2,0 metro.
6. Este equipo debe conectarse a un circuito que tenga una protección máxima contra las sobrecargas de 20 A.

Advertencia: Para La Protección Continua Contra Electroclusiones

1. Si se recibió este equipo sin el enchufe de alimentación, monte usted el enchufe correcto según el clave siguiente:
 - moreno - vivo
 - azul - neutral
 - verde/amarillo - tierra
2. Desconecte el suministro de energía antes de recambiar lámparas o prestar servicio de reparación.
3. Questa apparecchiatura e' da usarsi in ambienti secchi. Non e' da essere esposta ne alla pioggia ne all' umidita'.
4. Derive el servicio de reparación de este equipo al personal calificado. El interior no contiene repuestos que puedan ser reparados por el usuario.
5. Equipo de Clase I. Este equipo debe conectarse a la tierra.

Advertencia: Para Protección Continua Contra La Exposición A Radiación Ultravioleta (UV) Excesiva

1. Cambie el blindaje, los lentes si nota una avería visible, a tal grado que su eficacia se vea comprometida. Por ejemplo, en el caso de grietas o rayaduras profundas.
2. Jamás mire directamente a la lámpara en tanto ésta esté encendida.

Advertencia: Para Protección Continua Contra Lesiones Corporales

1. Al montare questa apparecchiatura, usare un secondo cavo di sicurezza.
2. Precaución: Una lámpara caliente puede constituir un peligro de explosión. No la abra por 5 minutos luego de haberla apagado. Lleve puestos, un protector ocular, y guantes al recambiar lámparas.
3. Las superficies del equipo pueden alcanzar temperaturas máximas de 160 grados centígrados. Deje que se enfrien por 5 minutos antes de tocarlas.
4. Cambie la lámpara si ésta se avería o deforma por acción térmica.

Appendice C: Importanti Informazioni Di Sicurezza

Avvertenza: Per Prevenire Incendi

1. Quest'apparecchiatura è disegnata per l'uso con le lampade specificate soltanto. L'uso di qualunque altra lampada di tipo può essere pericoloso e può nullo la garanzia.
2. Da non montare sopra una superficie infiammabile.
3. Mantenere l'apparecchio a un minimo di 1.0 metri (3.28 piedi) di distanza dai materiali combustibili.
4. Rimpiazzare i fusibili usando soltanto quelli del tipo e della taratura adatta.
5. Mantenere una distanza minima di 2.0 metri (6.56 piedi) dagli oggetti accesi.
6. Questa apparecchiatura e' da collegarsi ad un circuito con una protezione da sovraccarico massima di 20 amperes.

Avvertenza: Per Prevenire Le Scosse Elettriche

1. Se questa apparecchiatura è stata consegnata senza una spina del cavo di alimentazione, collegare la spina appropriata del cavo di alimentazione in base ai seguenti codici:
 - marrone - sotto tensione
 - blu - neutro
 - verde/giallo - terra
2. Disinnestare la corrente prima di cambiare la lampadina o prima di eseguire qualsiasi riparazione.
3. Este equipo se adecua a lugares secos solamente. no lo exponga a la lluvia o humedad.
4. Per qualsiasi riparazione rivolgersi al personale specializzato. L'utente non deve riparare nessuna parte dentro l'unità.
5. Aparecchio di Classe I. Questa apparecchiatura deve essere messa a terra.

Avvertenza: Per Proteggersi Contro Le Radiazioni Dei Raggi Ultravioletti

Non usare questa apparecchiatura se il sistema di chiusura della lampadina non e' completo o se gli scudetti, le lenti, si sono visibilmente danneggiati di maniera tale che la loro efficacia sia stata ridotta --- ad esempio, se vi sono visibili spaccature o graffi profondi. Mai guardare direttamente verso la lampadina quando sia accesa.



Avvertenza: Per Non Ferire Ad Altre Persone

1. Use cable secundario de seguridad al montar este aparato.
2. Avvertenza: La lampadina calda potrebbe esplodere. Spegnerla per 5 minuti prima di aprirla. Usare protezioni per le mani e per gli occhi prima di cambiare la lampadina.
3. Le superfici della apparecchiatura possono arrivare a temperature di 160 gradi centigradi (194 gradi f). Aspettare 5 minuti prima di maneggiare.
4. Cambiare la lampadina se si danneggia o se si e' deformata dovuto alle alte temperature.

Vigtig Sikkerhedsinformation

Advarsel: Beskyttelse mod elektrisk chock.

VIGTIGT!

LEDEREN MED GUL/GROEN ISOLATION MAA KUN TILSLUTTES KLEMME MAERKET 
ELLER .

Appendix D:

Menu Map

The Studio Command fixture's onboard menu system allows you to:

- Assign a DMX start channel
- Access fixture options such as, homing the fixture, viewing fixture status, crossloading software, and performing self tests
- Preset (PRST) programming options that allow you to create, store, and play scenes from the fixture's on-board memory.

For a more detailed description, see individual menu options listed in *Chapter 3: The Menu System* on page 21.

Note: *All Studio Command models use the same menu system. Yellow highlighted areas in the menu map table indicate options that have a different result or are not functional for Studio Command H fixtures.*

Studio Command Menu Map*

Level 1	Level 2	Level 3	Level 4	Level 5	Description	
ADDR	Cxxx				change the existing DMX start channel	
PRST	PLAY	OFF			set preset playback off	
		ON			set preset playback on	
		SCN			display which scene is currently playing	
	EDIT	SN01– SN16	SHUT DIM	CLSD		close the shutter
				P01– P26		select shutter strobe at periodic intervals from slow (P 01) to fast (P268)
				NN01– NN26		select shutter strobe at random intervals from slow (NN01) to fast (NN26)
				NK01– NK26		select shutter strobe at random intervals from slow (NK01) to fast (NK26), in synchronization with the random strobing of all other Studio Command fixtures on the link
				RS01– RS26		select shutter ramp open slow (RS01) to fast (RS26), snap shut
				SR01– SR26		select shutter snap open, ramp shut slow (SR01) to fast (SR26)
				RR01– RR26		select shutter ramp open, ramp shut slow (RR01) to fast (RR26)
				NR01– NR26		select the frequency to randomly ramp open slow (NR01) to fast (NR26), snap shut
				NS01– NS26		select the frequency to snap open, randomly ramp shut slow (NS01) to fast (NS26)
				OPEN		
D001– D255			select a dim value from dark (D001) to bright (D255)			

Level 1	Level 2	Level 3	Level 4	Level 5	Description		
PRST (cont.)	EDIT (cont.)	SN01 - SN16 (cont.)	PAN	-49.9– +49.9	select a pan value from -49.9% to +49.9% of the pan range		
			TILT	-49.9– +49.9	select a tilt value from -49.9% to +49.9% of the tilt range		
			COLC	Full Speed Mode			
				CON	continuous—select exact positioning at any point on the color wheel		
				CYCL	cycles through colors with cyan channel setting cycle speed.		
				RND	random—perform random color chase of 12 factory-selected colors using the three color wheels (speed set by cyan channel)		
				MSpeed Mode			
				MCON	continuous—select exact positioning at any point on the color wheel		
				MCYC	cycles through colors with cyan channel setting cycle speed.		
				MRND	random—perform random color chase of 12 factory-selected colors using the three color wheels (speed set by cyan channel)		
			CYAN	D000 - D255	select an exact position on the cyan color wheel from 0 (D000) to full saturation (D255) when COLC = CON		
				L000 - L255	sets speed of CYCL mode from stop (L000) to full speed (L255)		
				N000 - N255	sets speed of RND mode from stop (N000) to full speed (N255)		
			MAGN	D000 - D255	select an exact position on magenta color wheel from 0 (D000) to full saturation (D255)		
				CYCL	No function in CYCL or RND COLC modes.		
				RND			
			YELW	D000 - D255	select an exact position on yellow color wheel from 0 (D000) to full saturation (D255)		
				CYCL	No function in CYCL or RND COLC modes.		
				RND			
			ZOOM	Z000– Z255	select a zoom value for a beam angle from 18° (Z000) to 33° (Z255)		
			MSPD	252.7– 0.15	select a motor movement time in decimal seconds, from slow (252.7) to fast (0.15)		
				0.15– 252.7	select a motor movement time in decimal seconds, from fast (0.15) to slow (252.7)		
			MACR	MCOF	set all macro options off		
				P00- P56	pan sweep macro from small to large		
				TO	macros off		
				T00– T56	tilt sweep from small to large		
				CO	macros off		
				C00– CC34	clockwise circle macro		

Level 1	Level 2	Level 3	Level 4	Level 5	Description	
PRST (cont.)	EDIT (cont.)	SN01- SN16 (cont.)	MACR	CCO	macros off	
				CC00- CC34	counterclockwise circle macro	
				MCOF	set all macro options off	
			XFAD	X 0.1 - X 9.9	select the DIM and FCUS construct's crossfade time in increments of 0.1	
				X 10 - X166	select the DIM and FCUS construct's crossfade time in increments of 1	
			DLAY	D 0.1 - D 9.9	select the scene delay time in increments of 0.1	
				D 10 - D166	select the scene delay time in increments of 1	
			TIME	SEC	select seconds as the units of time used for the XFAD and DLAY constructs	
				MIN	select minutes as the units of time used for the XFAD and DLAY constructs	
			TIME (cont.)	HOUR	select hours as the units of time used for the XFAD and DLAY constructs	
	ZERO	OK?	erase any programming of the current scene by voiding all construct values / mark the end of the loop			
	COPY	FROM	FA01 - FA16	select a user A scene to copy from (source scene)		
			FA01 - FA16	select a user B scene to copy from (source scene)		
		TO	TA01 - TA16	select a user A scene to copy to (destination scene)		
			TB01 - TB16	select a user B scene to copy to (destination scene)		
	CAPT		SN01 - SN16	select a scene to capture a pre-programmed scene to (from your DMX controller)		
	DFLT	OK?		enable the factory-programmed preset scene sequence (self-demo) / erases any preset scenes previously programmed		
	SET	SEND				send all presets in current user
		FACT	ON		set factory defaults on	
			OFF		set factory defaults off	
SWAP		ON		set pan/tilt swap on		
		OFF		set pan/tilt swap off		
T/IN		ON		set tilt invert on		
		OFF		set tilt invert off		
P/IN		ON		set pan invert on		
		OFF		set pan invert off		
DSPL		ON		set the LED display on		
	OFF		set the LED display off			
	DIM		dim the LED display			
D/IN	ON		select inverted LED display orientation			
	OFF		select normal LED display orientation			

Level 1	Level 2	Level 3	Level 4	Level 5	Description		
MODE	LMPL			ON	enable lamp hour warning message		
				OFF	disable lamp hour warning message		
	DLOS			LONG	shutter will remain open until shutdown if DMX data is lost		
				SHRT	shutter will close one second after DMX data is lost Note: In Studio Command H Models, the lamp will douse one second after DMX data is lost.		
	USER	A				select user A settings	
		B				select user B settings	
		COPY	PRST	A → B			copy user A presets to user B
				B → A			copy user B presets to user A
			SETT	A → B			copy user A settings to user B
				B → A			copy user B settings to user A
		ALL	A → B			copy user A presets and settings to user B	
			B → A			copy user B presets and settings to user A	
	XLD				crossload fixture software to other Studio Command fixtures on the link		
	TEST	HOME				home the fixture	
LAMP		ON		strike the lamp			
		OFF		extinguish the lamp			
BOOT				copy the boot sector			
SELF		ALL		self test all constructs			
		PAN		self test pan movement			
		TILT		self test tilt movement			
		CYAN		self test cyan color wheel movement			
		MAGN		self test magenta color wheel movement			
		YELW		self test yellow color wheel movement			
		ZOOM		self test zoom movement			
		SHUT		self test shutter strobe movement			
DIM				self test dim flag movement.			
S/UP				place the fixture in setup mode for mechanical homing			
DISP				self test the LED display			
ENCD		ON		restore pan and tilt encoder operation			
		OFF		disable pan and tilt encoder operation			
CODE				Factory use only			

Level 1	Level 2	Level 3	Level 4	Level 5	Description	
INFO	SENS	TILT			view whether the tilt sensor is obstructed ("ON") or is not obstructed ("OFF")	
		PAN			view whether the pan sensor is obstructed ("ON") or is not obstructed ("OFF")	
		TPOS			view the tilt position encoder status	
		PPOS			view the pan position encoder status	
	UNUM					Customer Service use only
	DMX Values displayed when standard protocol is selected					
	DMX	FIXT	BRKS			view the number of DMX breaks
			FE			view the number of DMX framing errors
			OV			view the number of DMX overruns
			STRT			view the DMX start code value
			PANH			view the DMX high resolution pan value
			TLTH			view the DMX high resolution tilt value
			TLTL			view the DMX low resolution tilt value
			COLC			view the DMX color control channel value
			CYAN			view the DMX cyan color wheel position value
			MAGN			view the DMX magenta color wheel position value
			YELW			view the DMX yellow color wheel position value
			ZOOM			view the DMX zoom lens position value
			SHUT			view the DMX shutter strobe value
			DIM			view the DMX shutter dim flag value.
			MSPD			view the DMX MSpeed time value
			MACR			view the DMX macro value
	CNTL			view the DMX control channel value		
	DATA		C001 - C512		view the DMX data for the selected DMX channel	
	TEMP	PCB			view the current temperature at the logic board (C)	
		HEAD			view the current internal head temperature (C)	
	F/RS		reset fixture hours to zero (<i>press and hold the <Enter> button for five seconds to change the value</i>)			
	F/HR		view current number of fixture hours			
	L/RS		reset lamp hours to zero (<i>press and hold the <Enter> button for five seconds to change the value</i>)			
	L/ST		view the current number of lamp strikes			
	L/HR		view the current number of lamp hours			
	VER		view the fixture's software version			

